

Decorative Wire Mesh

We are engaged in the custom design and manufacturing of various architectural decoration meshes for interior and external applications. Including wall cladding, ceiling, indoor partition, space division, elevator decoration, decorative screen, etc.

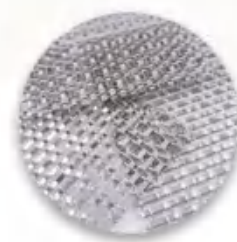

Decorative mesh, crafted with precision and creativity, serves as an aesthetic and functional element in architectural and interior design. Whether used in room dividers, wall panels, or exterior facades, decorative mesh adds a touch of elegance, texture, and modern flair to spaces, offering a visually appealing solution for those seeking both form and function in their design projects.

Decorative mesh is a versatile material used for both aesthetic and functional purposes in a variety of construction and design applications. Such as the decoration of building exterior walls, ceilings, stairs, balcony and aisle railings, decorative screens, signs, lamps and furniture scenes.

Benefits of Decorative Mesh

● Aesthetic Appeal

- **Customization:** Available in various materials, patterns, and finishes to suit different design styles.
- **Texture and Depth:** Adds visual interest and complexity to surfaces.

● Functionality

- **Ventilation:** Allows air to flow while providing protection and security.
- **Light Control:** Offers shading and diffuses light, reducing glare and heat.
- **Acoustic Properties:** Certain types can help in sound absorption and noise reduction.

● Durability

- **Weather Resistance:** Suitable for both indoor and outdoor use, resistant to corrosion and environmental damage.
- **Strength:** Provides structural support and protection in addition to decorative purposes.

● Versatility

- **Wide Applications:** Used in architecture, interior design, industrial applications, and artistic installations.
- **Easy Maintenance:** Most decorative meshes require minimal upkeep, making them practical for various environments.

We provide different types of decorative nets including:

- ◆ Woven Wire Mesh
- ◆ Perforated Metal Mesh
- ◆ Expanded Metal Mesh
- ◆ Knitted Wire Mesh
- ◆ Chain Link Mesh
- ◆ Plastic and Fabric Mesh

DECORATIVE WIRE MESH TYPE



Ring Mesh Curtain

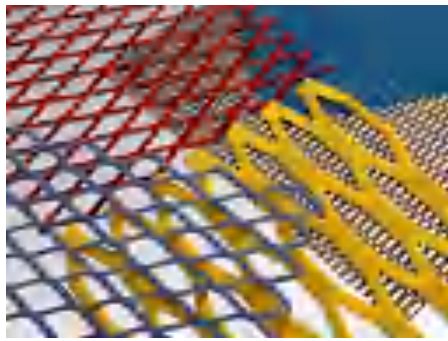

Decorative Expanded Metal mesh



Decorative Crimped Woven Mesh

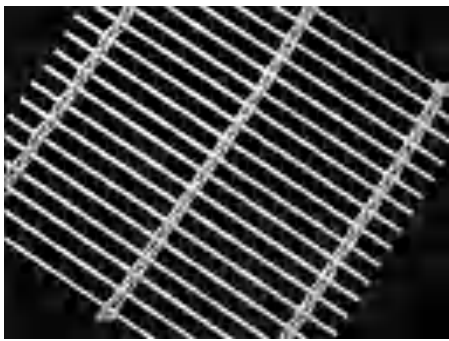

Woven Wire Drapery



Spiral Weave Mesh



Metal Coil Drapery



Chain Link Curtain



Stainless Steel Rope Mesh



Laminated Glass Metal



S Hook Ring Mesh Curtain



Metallic Fabric Cloth



Metal Bead Curtain

Ring Mesh Curtain

Ring mesh, also named chainmail curtain or metal ring mesh, is an emerging type of architectural decorative curtain. Ring mesh curtains consist of linked metal rings together. Compared with individually-welded rings, the linked pattern has supple and free-flowing sheets. These features make the curtain easy to pass through.

Compared with metal coil curtain, chain link curtain it has a high tensile strength that can withstand great tension. Ring mesh curtain has been recognized by more and more customers, on one hand, its excellent properties like high tensile strength and rust resistance ensure it has longer service time than ordinary curtain, on the other hand, it has beautiful appearance with low maintenance advantage that can be used as internal and external decoration, partition curtain wall, window treatments, lamp decoration, etc.

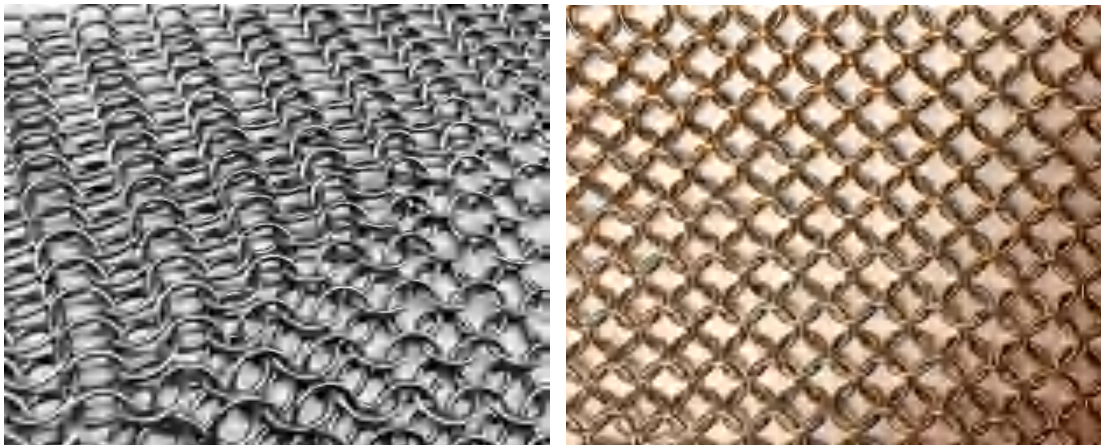

Specification

Product name: Stainless steel ring mesh curtain, chainmail curtain

Material: 304/316 stainless steel, galvanized steel or carbon steel.

Finish: Raw, anodic oxidation, Titanium plating

Color: Silver, gold, bronze, black. Other colors also available.

Wire Gauge: 0.5 mm - 3 mm.

Ring Diameter: 3 mm - 30 mm.

Connection of ring: Welded or non-welded.

Length x Height: No restrictions.

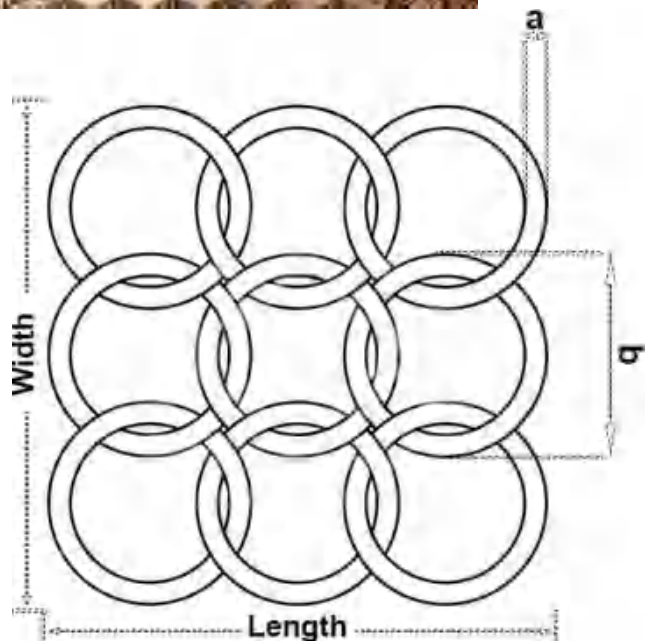

Features

Fireproof: Its melting point is far higher than that of cloth curtain.

Stable: No shrinks or stretches when used.

Mildew proof: It will be fine when used in humidity conditions.

Sun rot proof: No matter how strong sun shine is, metal ring curtain will not be affected.

Light diffusing: Light filtration is controlled by curtain fullness and light conditions.

No Maintenance: Stains can be washed off by mild soap water.

Permanent: It will last longer than your life except you don't like to hang it any more.

Note: Special size and specifications can be made according to customers requires.

Common Size Of Metal Ring Mesh

Material	Wire Gauge(mm)	Ring Diameter(mm)	Approx. Weight (kg/m ²)
304/316	0.8	7	3
304/316	1	8	4.1
304/316	1	10	3.3
304/316	1.2	10	4
304/316	1.2	12	4.1
304/316	1.5	10	8.8
304/316	1.5	12	6.4
304/316	1.5	15	5.2
304/316	2	20	6.4
304/316	2	25	5.8
304/316	3	30	10

Various Colors & Finishes



Natural



Brass/Gold



Bronze



Black

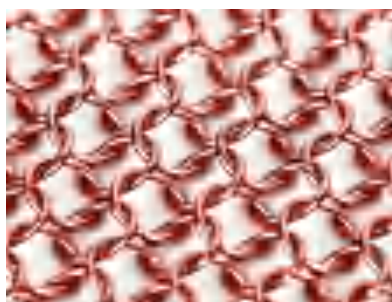

Red/Copper

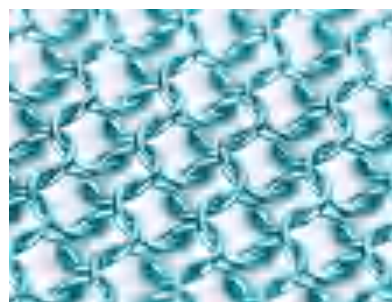

Cyan Blue

Installation

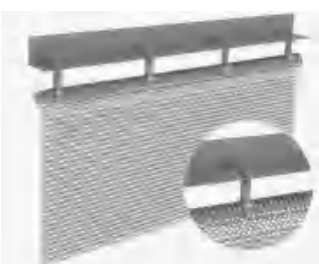
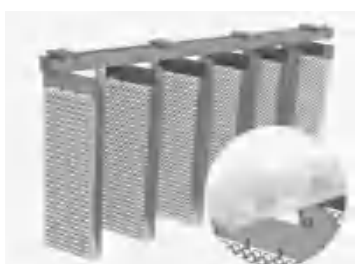

1. Curve Slide I-Beam Track

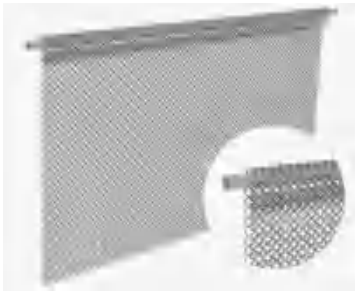

2. Straight Slide U-Channel Track

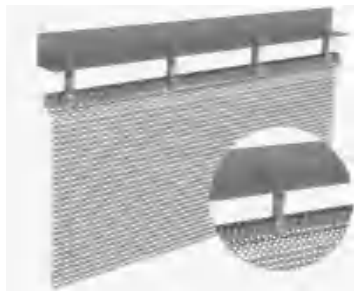

3. Straight Slide Track



4. Straight Fixed Track

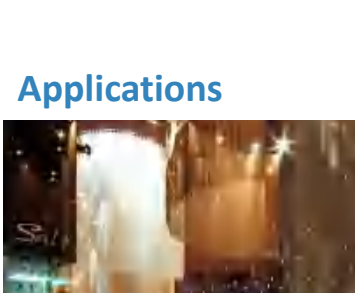

5. Rod and Angle Bar



6. Rod Slide Track

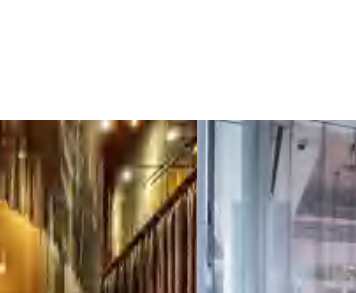

Applications

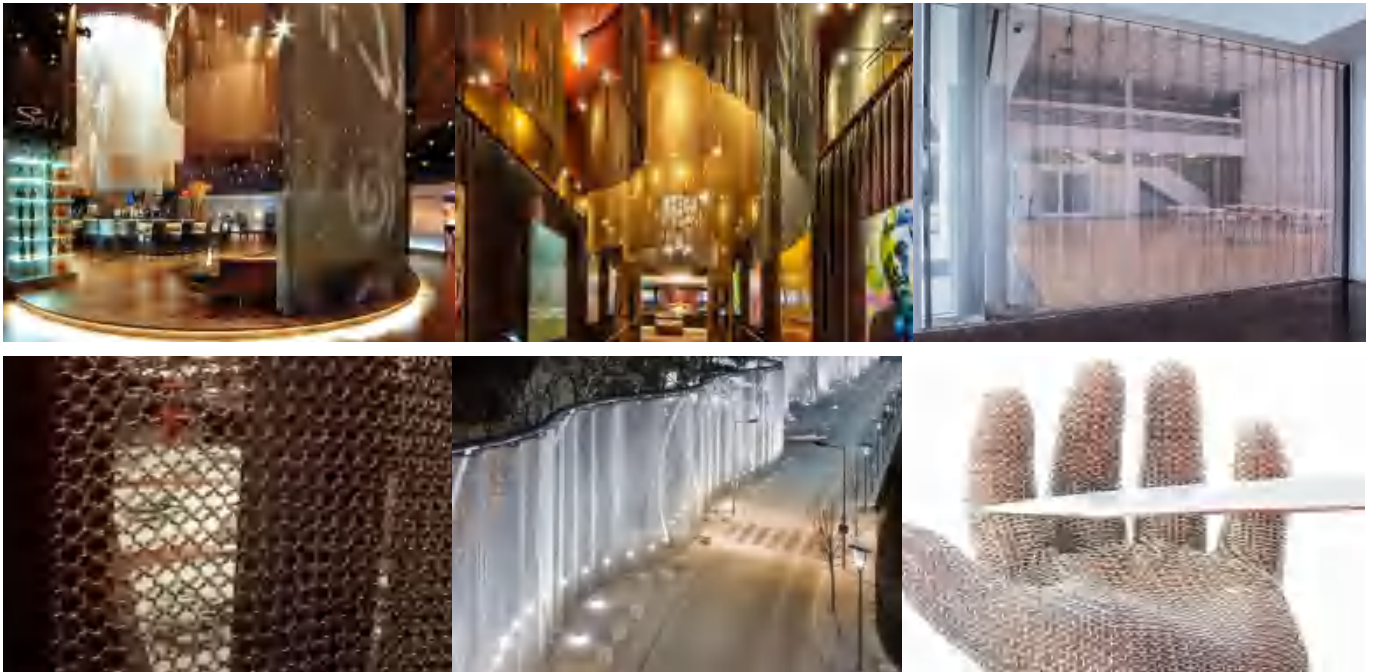

Decorative Expanded Metal mesh

Expanded metal mesh also called stretch metal or expandable metal, is produced by slitting and stretching metal plate/sheet. During the manufacturing process, no material is wasted, economical and eco-friendly, so it has become the preferred choice for applications of architectural ornamental projects. E.g. building facade & cladding, ceiling, partition wall, railing as well as functional sunshade panels.

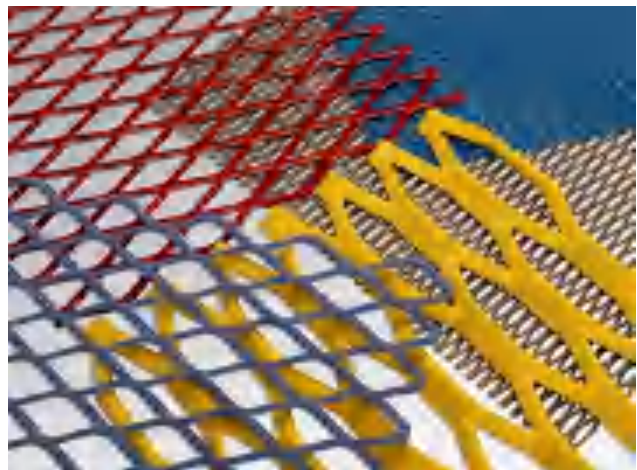
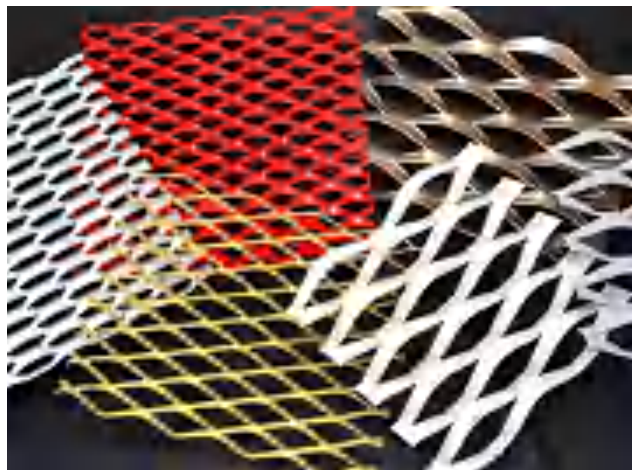

Specification

Materials: aluminum, Al-Mg alloy, low carbon steel, stainless steel, copper.

Hole shapes: diamond, square, hexagonal, tortoise shell.

Surface treatment: anodized, galvanized, PVC coated, spray painting, powder coated.

Colors: golden, red, blue, green or other RAL colors.

Thickness: 0.3 mm – 10.0 mm.

Length: ≤ 4000 mm.

Width: ≤ 1500 mm.

Features

Attractive appearance.

Corrosion resistance

Strong and durable

lighter weight.

Good ventilation.

Environmentally friendly.

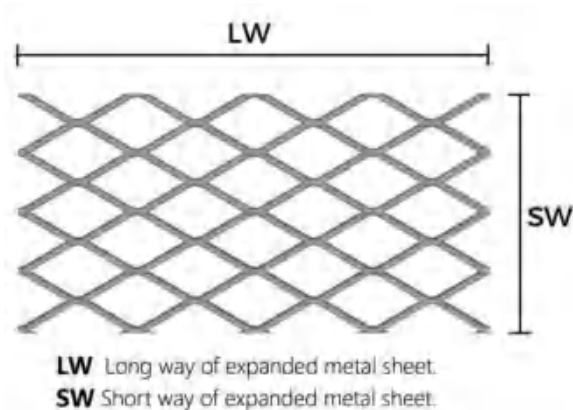
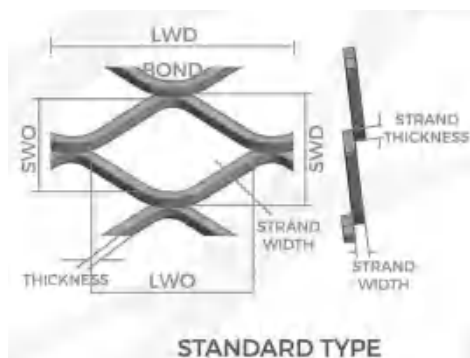
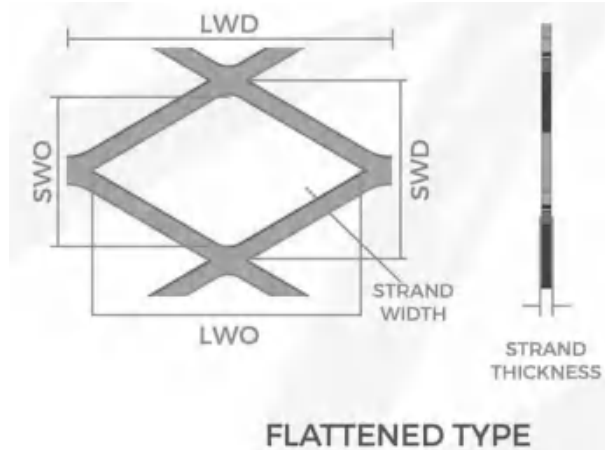

Specification of Decorative Expanded Metal Mesh

Sheet Thickness (mm)	Opening in Width (mm)	Opening in Length (mm)	Stem (mm)	Roll Width (m)	Roll Length (m)	Weight (kg/m ²)
0.5	25	4.5	0.5	0.5	1	1.8
0.5	10	25	0.5	0.6	2	0.73
0.6	10	25	1	0.6	2	1
0.8	10	25	1	0.6	2	1.25
1	10	25	1.1	0.6	2	1.77
1	15	40	1.5	2	4	1.85
1.2	10	25	1.1	2	4	2.21
1.2	10	40	1.5	2	4	2.3
1.5	25	40	1.5	1.8	4	2.77
1.5	25	60	2.6	2	3.6	2.77
2	18	50	2.1	2	4	3.69
2	20	60	2.6	2	4	3.69
3	40	80	3.8	2	4	5.00
4	50	100	4	2	2	11.15
4.5	50	100	5	2	2.7	11.15
5	50	100	5	1.4	2.6	12.39
6	50	100	6	2	2.5	17.35
8	50	100	8	2	2.1	28.26

Applications

Outdoors

Facades of large buildings, railings of stairs, fencing of balcony, walkways, gardens, schools, residential perimeters.

Indoors

Interior wall, railings of stairs, fencing of walkways, ceilings, partitions, furniture, such as tables, shelves, cabinets, etc.



Decorative crimped woven mesh

Decorative crimped woven mesh is made from stainless steel, aluminum, cooper, brass material mostly, and customer may choose some special materials as the option due to the special environment. Decorative crimped woven mesh is widely used in business building, restaurant and hotel, it not only has superior feature than the original architecture elements, but also has nice appearance which will catch our eyes easily, it becomes more and more popular among designers for construction decoration.

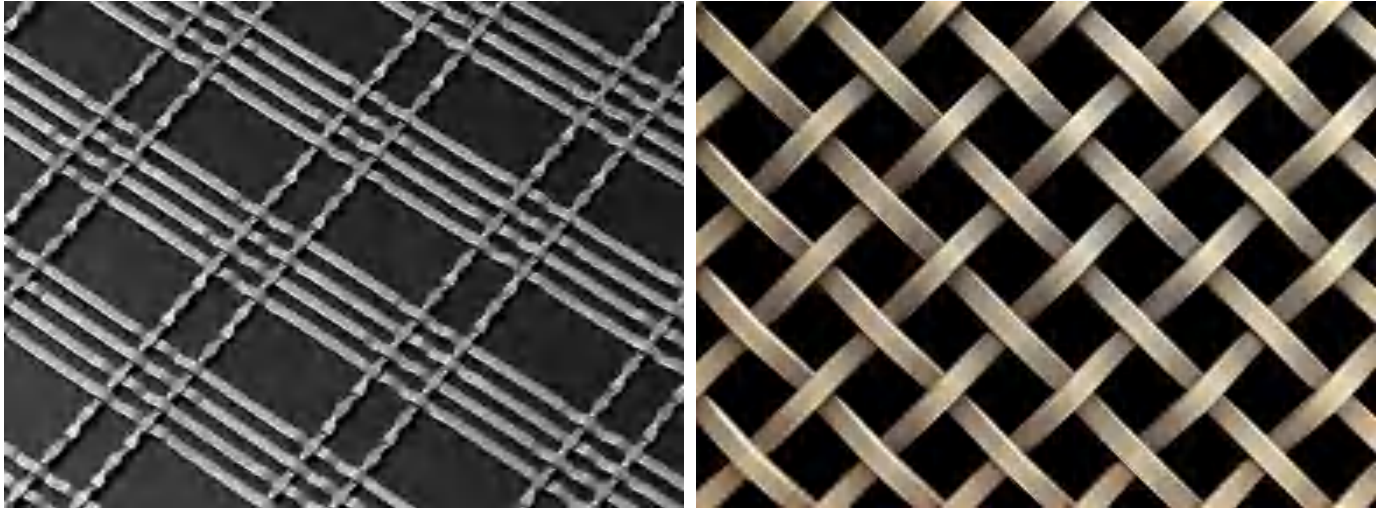

Product name: Decorative crimped woven mesh

Material: Aluminum, copper, brass, stainless steel, carbon steel, etc.

Process: After first rolling, two-way wave bending, locked bending, flat-topped cured, two-way bending, on-way wave bending, rectangular mesh weaving, mesh has woven solid, durable, mesh uniform characteristics.

Mesh count: 1-24mesh

Width: 0.5~3.0m(as request) Mesh

Type: square mesh and rectangle mesh

Edge type: plain, bent and reinforced hooked

Weaving Method: double crimped, flat top crimped, intermediate crimped and lock crimped

Features

Variety of styles and mesh openings

Variety of unique patterns

Remarkably versatile

Low maintenance construction

Material sustainability

Different Colors

Decorative crimped woven mesh specification list:

Number	Diameter(mm)	Aperture(mm)	Weigh(kg)
1	2	10	4.2
2	2.5	15	4.5
3	3	25	4.08
4	3.5	30	4.64

5	4	40	4.61
6	4.5	50	4.67

Decorative crimped woven mesh types:



Flat wire width (a): 17.85 mm
Flat wire thickness (b): 2.5 mm
Aperture (c): 24.5 mm
Open area: 61.72%
Weight: 16.95 kg/m²
Material: SS304/SS316/SS316L
Surface finish: baking varnish and plating
Color: natural, bronze, antique brass and brass

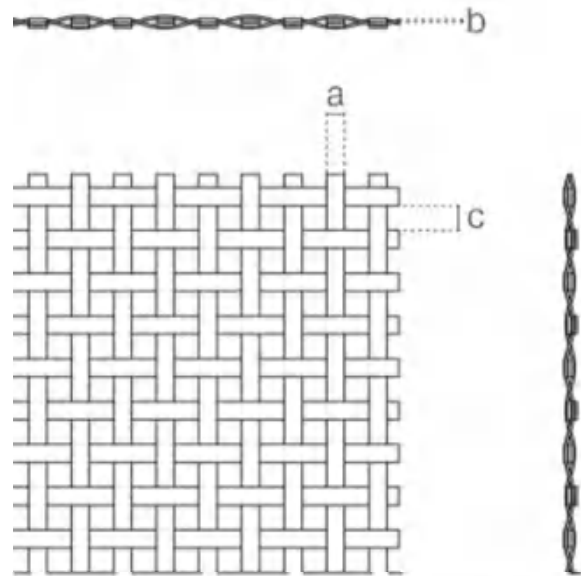

Flat wire width (a): 4.9 mm
Flat wire thickness (b): 2 mm
Round wire diameter (c): 1 mm
Round wire aperture (d): 40 mm
Aperture (e): 40 x 40 mm
Aperture (f): 70 x 70 mm
Open area: 66.99%
Weight: 5.76 kg/m²

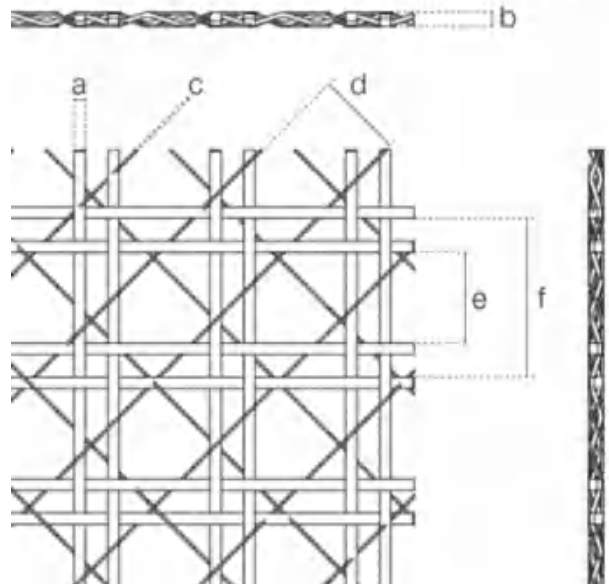

Flat wire width (a): 3.12 mm
Flat wire thickness (b): 1 mm
Aperture (c): 3.44 mm
Open area: 28.35%
Weight: 7.26kg/m²
Material: SS304/SS316/SS316L
Surface finish: baking varnish and plating
Color: natural, bronze, antique brass and brass

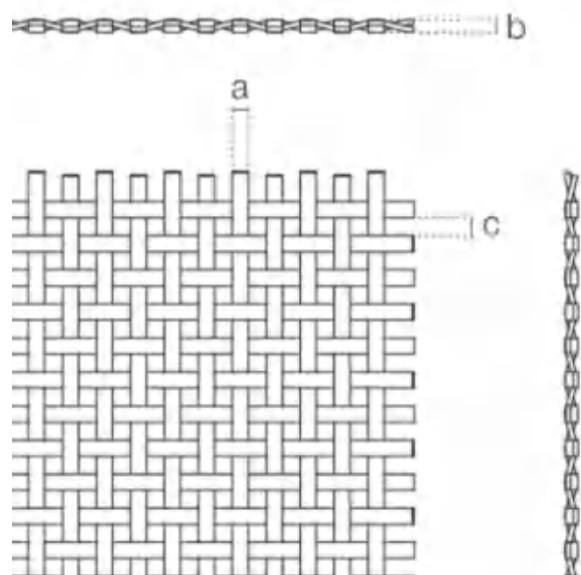

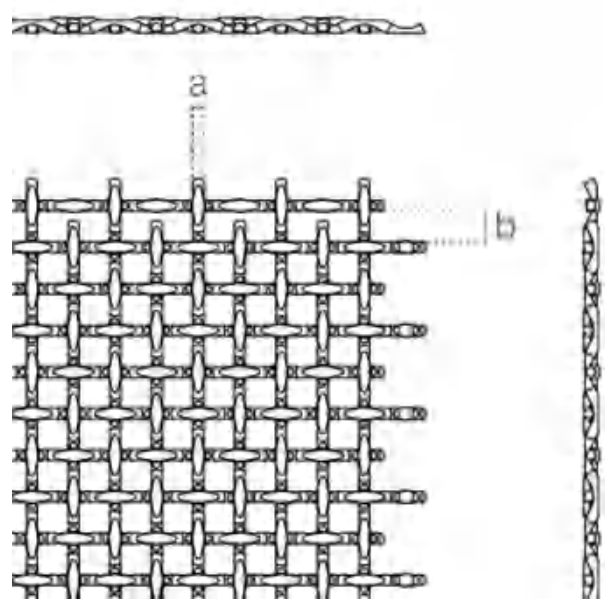

Round wire diameter (a): 3 mm
Round wire aperture (b): 8.8 mm
Open area: 53.3%
Weight: 7.77 kg/m²
Material: SS304/SS316/SS316L
Surface finish: baking varnish and plating
Color: natural, bronze, antique brass and brass

Applications

- Wire mesh facades
- Shade screens
- Architecture ceilings
- Metal draperies for walls, partition and isolation screens
- Staircases isolation screen, elevator cabins screen
- Floor covering fabric



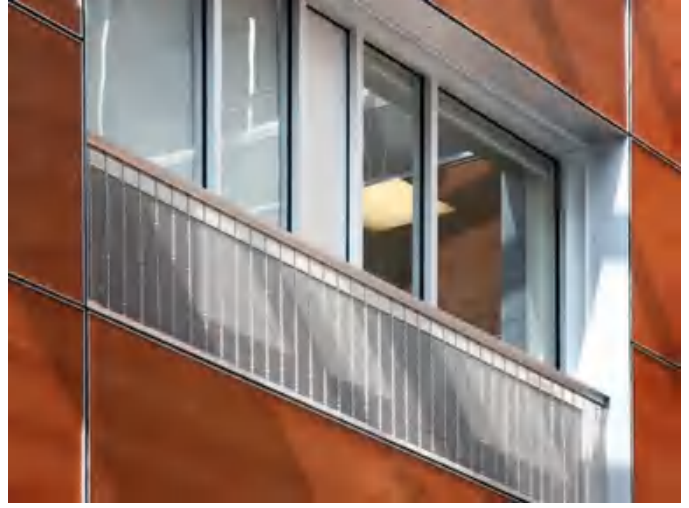

Woven Wire Drapery

Woven wire drapery is made of corrosive resistant stainless steel rope/cable and wire/rod. It is designed by various spaces, weights and weaves. Woven wire drapery is also named flexible metal drapery, it is solid and stable and has high security feature among decorative meshes, it could be used as both interior and exterior decoration such as: room dividers, partitions, wall covering, facades, stairs, elevator cabs, rails, column curtains and other decorative items.

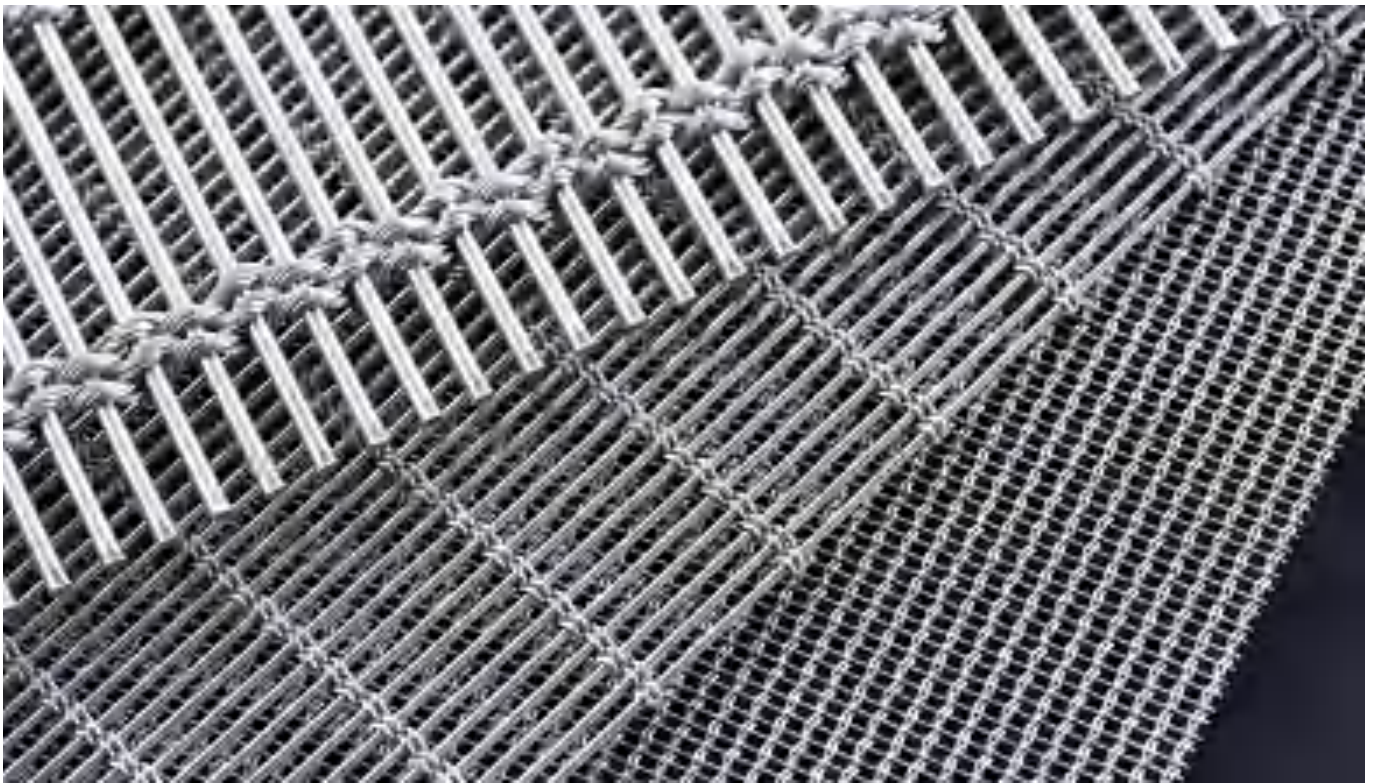

Specification

Product name: Woven wire drapery, architectural wire mesh

Material: Stainless steel 316, 304.

Cable diameter: 3.0 mm

Rod diameter: 1.5 mm, 2.0 mm

Total thickness: 6.50 mm, 6.8 mm, 7.5 mm, 8.00 mm

Max. width: 3,600 mm-4,000 mm

Open area: 80% / 56% / 54% / 16%

Color: Silver, yellow, etc.

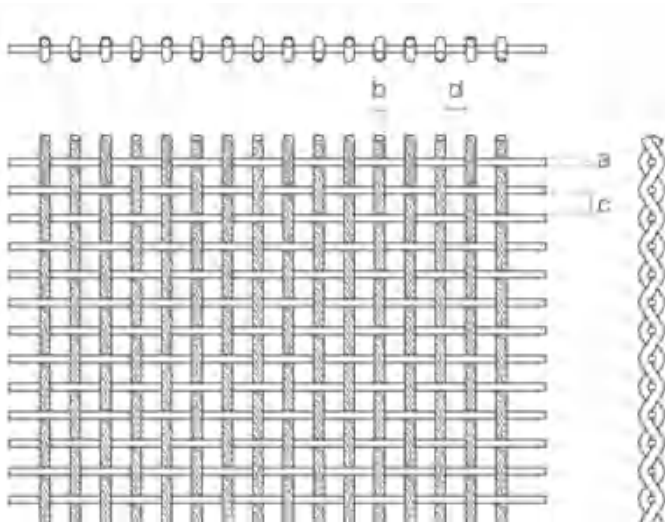

Round wire diameter (a):
0.5–4 mm

Round wire spacing (c):
2–35 mm

Rope diameter (b):
2–4 mm

Rope spacing (d):
1–20 mm

Woven types

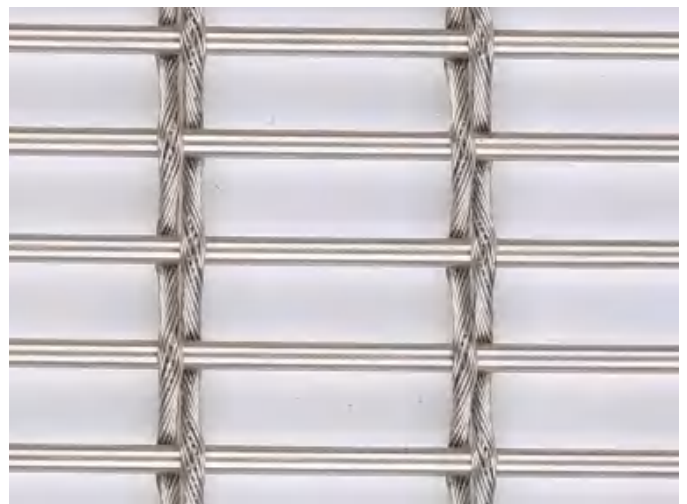
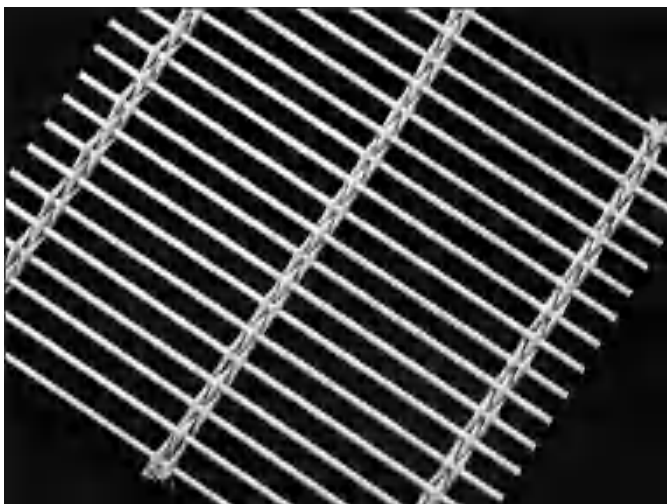
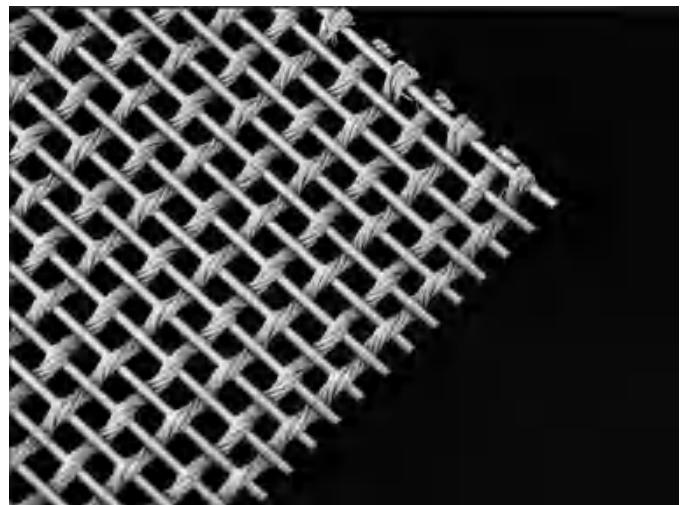
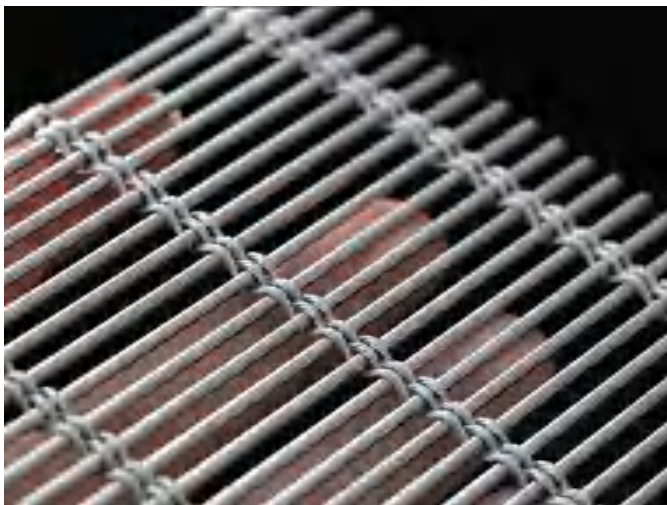

Extensive Practicality

For the same woven type, after changing the specifications and materials of the metal mesh, it is not only workable for ceiling design and furniture in the interior, but also can be used as outdoor building cladding, and shading mesh.



Copper architectural metal mesh as ceiling cover



Stainless steel architectural metal mesh as cladding

Applications

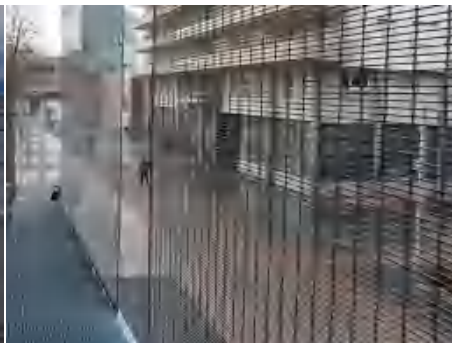
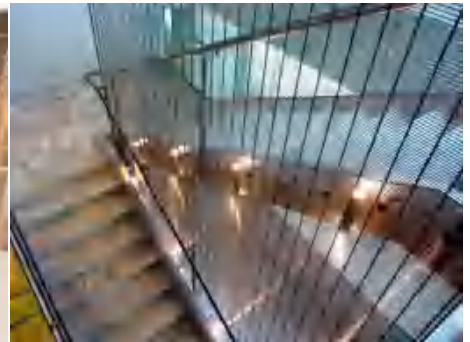
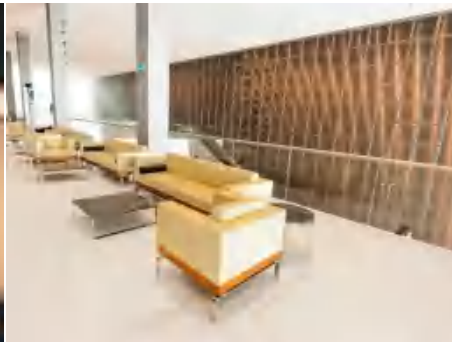

Spiral Weave Mesh

Spiral weave mesh is also called conveyor belt mesh, it is composed by straight or bent rod/flat bar in horizon and bend wires in vertical. It is very flexible and has strong mesh, this kind of mesh is used in industry for transportation belt most originally. Afterwards, it was increasing gradually used in architecture field and decoration field due to its good pattern, nice appearance and charming color. Spiral weave mesh could bear hard surroundings and keep from damage, it is similar to woven wire drapery.

Material: aluminum wire, stainless steel wire, Copper wire, brass wire and other alloy wires.

Spiral wire type: flat wire or round wire.

Spiral wire diameter:

- Flat wire diameter: 2.5 mm, 3 mm, 3.2 mm, 3.3 mm, etc.
- Round wire diameter: 1.2 mm, 2.6 mm, etc.

Spiral wire pitch: 3 mm, 8 mm, 12.5 mm, 20 mm, 24.3 mm, 35 mm, 36 mm, 38 mm and so on.

Rod wire type: straight wire or crimped wire.

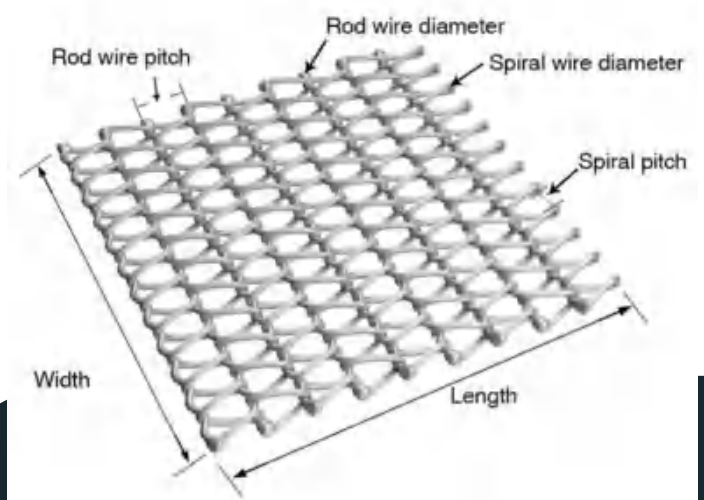

Rod wire diameter:

- Straight wire diameter: 2 mm, 3.5 mm and so on.
- Crimped wire diameter: 1.3 mm, 2 mm, 2.5 mm, 2.6 mm, 3 mm, 3.5 mm, etc.

Rod wire pitch: 13 mm, 15 mm, 22.5 mm, 25 mm, 30 mm, 40 mm, 60 mm and 64.5 mm.

Specification of spiral Wire Mesh

Normal Mesh Thickness(mm)	Spiral Pitch(mm)	Spiral Wire Dia(mm)	Rod Wire Pitch(mm)	Rod Wire Dia(mm)
7.7	16.94	1.63	19.05	1.63
8.9	16.94	2.03	19.05	2.03
7.3	10.16	1.42	12.70	1.42
6.7	10.16	1.63	12.70	1.63
6.0	7.26	1.22	8.47	1.22
6.0	7.26	1.42	8.47	1.42
6.4	7.26	1.63	8.47	1.63
6.1	6.35	1.42	6.35	1.42
6.4	6.35	1.63	6.36	1.63
4.0	5.08	0.91	6.35	1.22
5.2	5.08	1.22	6.36	1.22
5.6	5.08	1.22	5.08	1.22

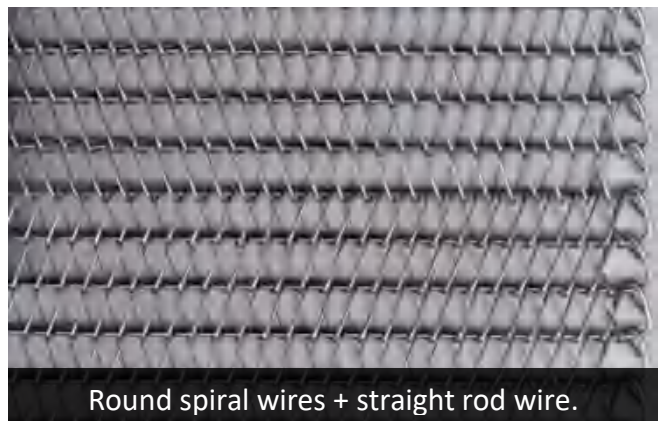

Installation

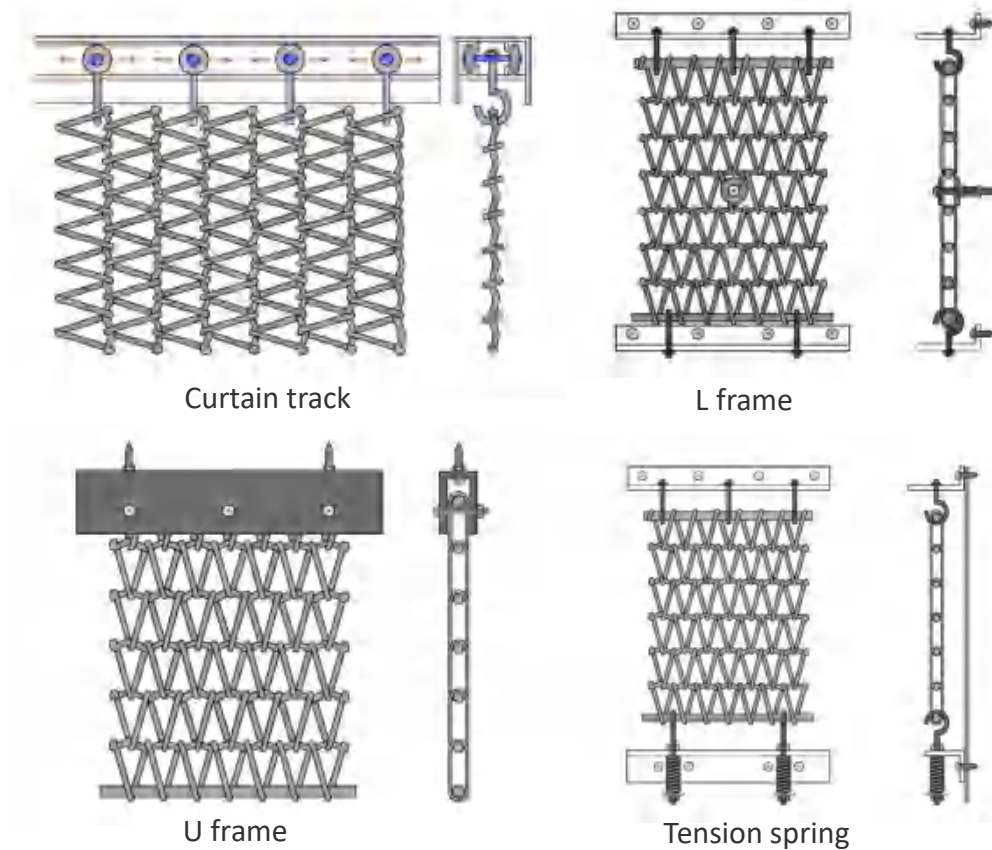

Applications

Suitable applications. Museum. Sport stadium. Office. Hotel. Exhibition hall. Building facades. Shopping mall.

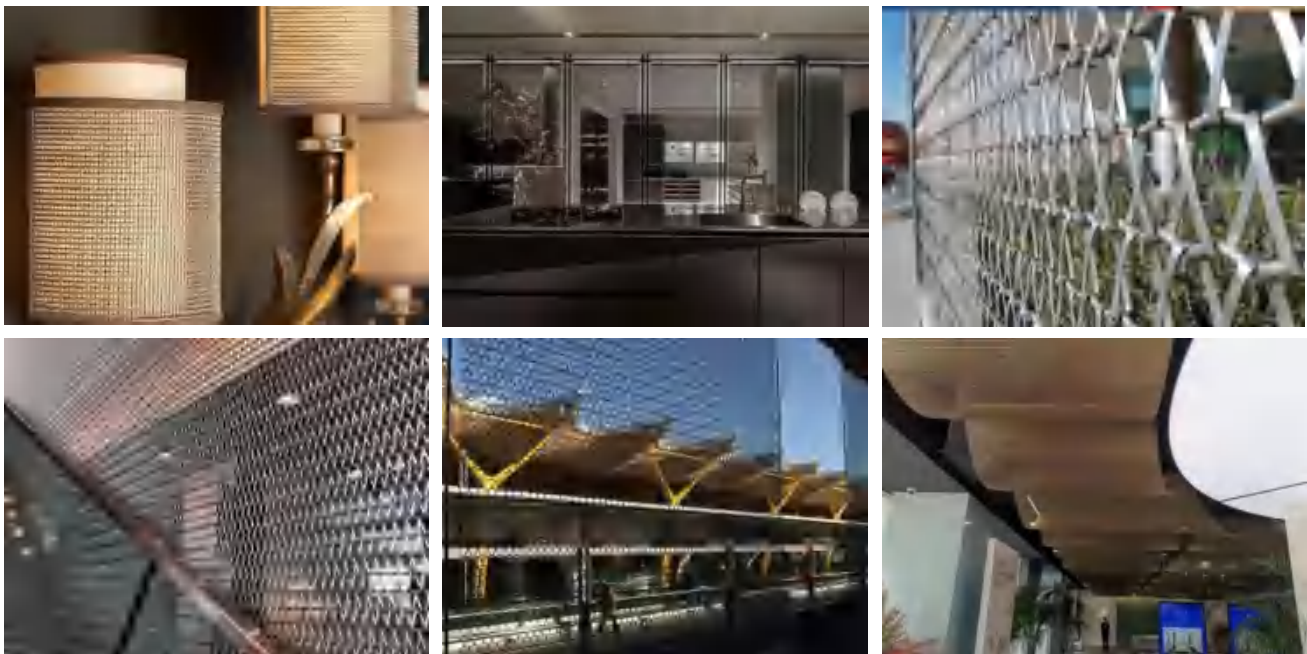

Metal Coil Drapery

Metal coil drapery is a type of decorative mesh curtain made from low carbon steel, stainless steel, aluminum, copper, brass wires. Compared to chain link curtain, metal coil drapery is a whole piece and could sliding on the channel. Metal coil drapery is widely used in interior and exterior architectural

decoration. It is applied broadly in exhibition halls, living rooms, restaurants, hotels, bathroom.

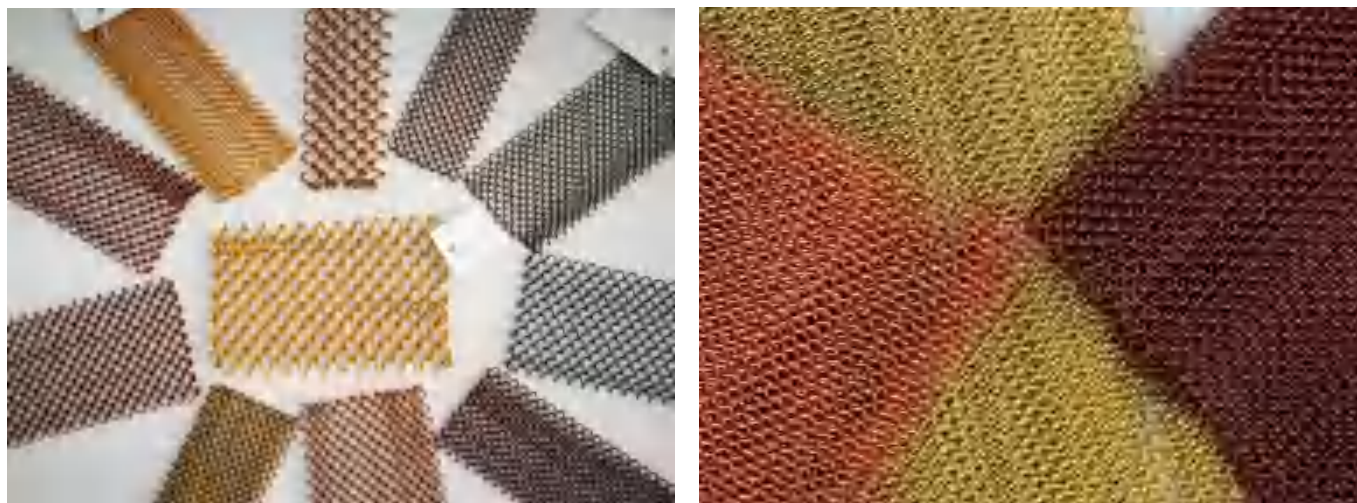

Material: stainless steel, copper, aluminum, aluminum alloy, etc.

Wire diameter: 0.5 mm - 1.2 mm.

Aperture size: 3 mm - 20 mm.

Open area: 40% - 85%.

Finish: zinc coated, copper plated, metallic color spray, etc.

Color: original metallic color or spray into other colors.

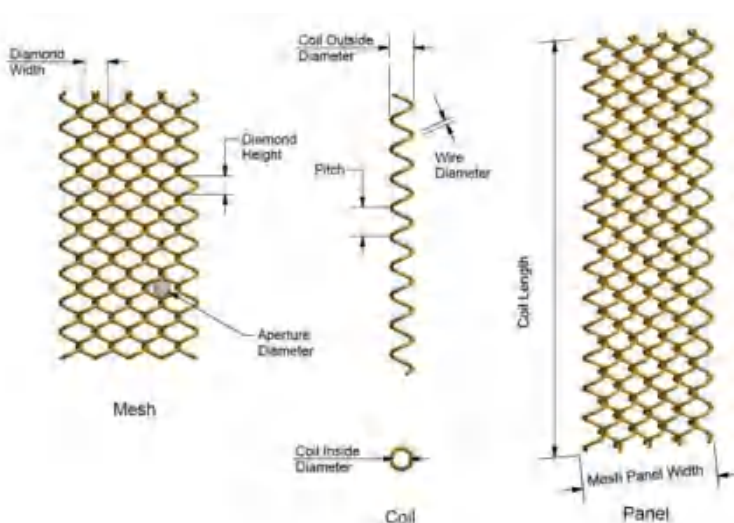

Specifications

Material	Wire diameter	Aperture		Thickness	Weight
Carbon steel	0.9mm	6.3mm	3/16"	5.8mm	4.0kg/m ²
	1.2mm	8.5mm	1/4"	7.1mm	6.0kg/m ²
	1.0mm	6.8mm	1/4"	6.5mm	5.5kg/m ²
Stainless steel	1.0mm	8.4mm	1/4"	6.7mm	3.5kg/m ²
	1.2mm	6.8mm	3/16"	6.5mm	5.8kg/m ²
	1.2mm	8.5mm	1/4"	7.1mm	5.0kg/m ²
Aluminium-magnesium alloy	1.2mm	8.5mm	1/4"	7.1mm	2.0kg/m ²
	1.2mm	6.8mm	3/16"	6.5mm	2.5kg/m ²
	1.0mm	5.5mm	3/16"	5.5mm	1.7kg/m ²
	2.0mm	12mm	1/2"	12.0mm	3.0kg/m ²

More product requests please contact us for customization

Surface treatment

Metal coil drapery is usually made of aluminum alloy or stainless steel, and the most common surface treatment is spray painting and pickling.

Spray painting: Aluminum alloy metal coil drapery is mainly used in indoor environments. After multiple layers of paint and baking treatments, the aluminum metal coil drapery presents the desired custom

color, including the most popular brass, copper, silver and gunmetal colors. In order to ensure that the spiral mesh can perfectly present the desired gloss effect, Boegger uses metallic paint similar to that used in automotive body painting during the painting process.

Pickling: stainless steels metal coil drapery is mainly used in harsh environments such as outdoor or coastal areas, pickling after the production of metal coil drapery can remove grease impurities on the surface and show the luster of the metal itself. After the production of the spiral mesh, pickling is performed to remove surface grease and impurities, revealing the natural metallic luster.



Metallic color coil fabric.



Copper coil fabric



White coil fabric.



Golden color coil fabric.

Features

- Light diffusion and good ventilation.
- UV resistant and flame resistant.
- Beautiful appearance and various color.
- Versatility and decorative effects.
- Aesthetic appeal and functionality.
- Finishes are beautiful and resilient.
- Color never fading and paint never dropping.
- Gorgeous and high-end.
- Durability and flexibility.

Applications

With versatility, variety of color, durability and flexibility, metal coil drapery provides a new decoration style for various functions and practical areas.

Curtain: shower curtain, window curtain, door curtain, etc.

Space divider: for home, office, restaurant, hotel, supermarket, etc.

For decoration: light partitioning, ceilings, wall covering, display, etc.

For protection: cladding, facade, enclosures, shades, etc.

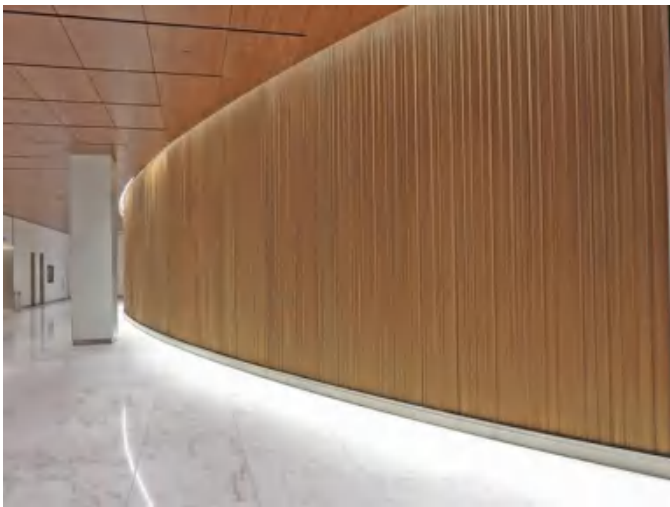
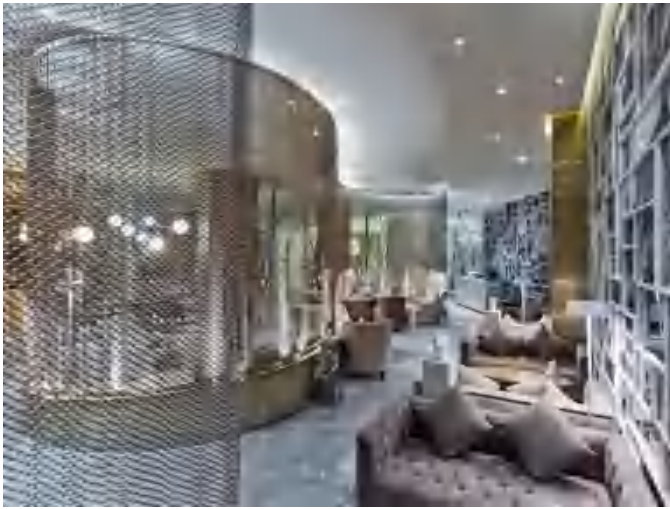

Chain Link Curtain

Chain link curtain, it is also named as chain fly screen, except for using as decorative screen or divider for residential or commercial places, it is also could be used as a barrier of flying insects. It is the most popular decorative mesh curtain in our daily life due to its insects barrier, nice appearance and cost-effective features. Chain link curtain is made from aluminum material and with various colors covering, designer always design logo on the chain link curtain when using for office, hotel, restaurant, etc.



Material: 100% aluminum material.
Wire diameter: 0.8mm,1.0mm,1.2mm, 1.3mm,1.6mm,1.8mm,2.0mm, etc.
Hook width: 9mm or 12mm.
Hook length: 17mm,20.4mm,22.5mm, 24mm and so on.
Curtain size: 0.8m × 2m,0.9m × 1.8m, 0.9m × 2m,1m × 2m, 1m × 2.1m, etc.
Surface treatment: anodized.
Finish:gloss or matte.
Colors: silver, black, green, blue, red, purple or customized

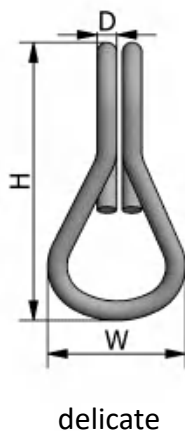
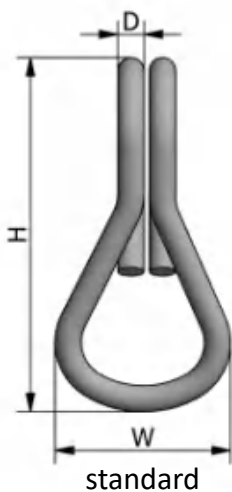
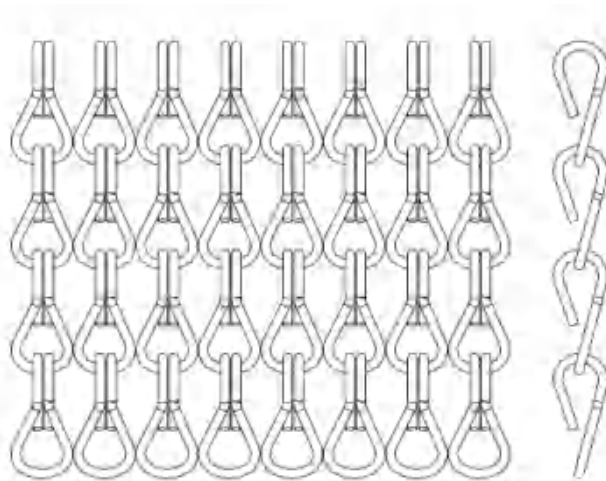

<p>Standard</p> <ul style="list-style-type: none"> - Wire diameter (D): 2.0 mm - Hook width (W): 12.0 mm - Hook length (H): 24 mm <p>Delicate</p> <ul style="list-style-type: none"> - Wire diameter (D): 1.5 mm - Hook width (W): 8.5 mm - Hook length (H): 17 mm
--

Common size:

- 1.6 mm × 24 mm × 12 mm
 - 2.0 mm × 24 mm × 12 mm
 - 1.6 mm × 33 mm × 12 mm
 - 2.0 mm × 33 mm × 12 mm
- More curtain chain link sizes can be customized.



Splicing Styles

Through different stitching styles, more individualized designs can be achieved. The chain link curtain can be spliced out of any patterns, even photos.

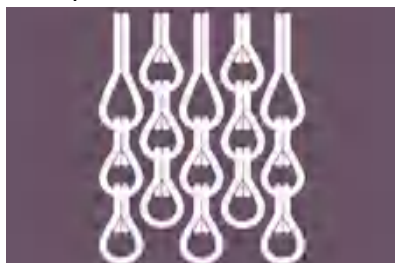

Standard style: Classic style.Perfect symmetry. Chain lines harmonically aligned. Suitable for most uses.

Half-drop style: The intense option. Half-drop's density provides higher opacity and a stronger visua impact

Color stitching: The combination of unlimited color options and stitching styles can display various patterns, text or photos on the curtains.

Category

Chain knot and arrangement differences make different chain link curtain effect.

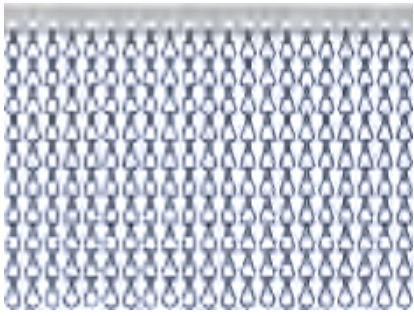

Classical delicate

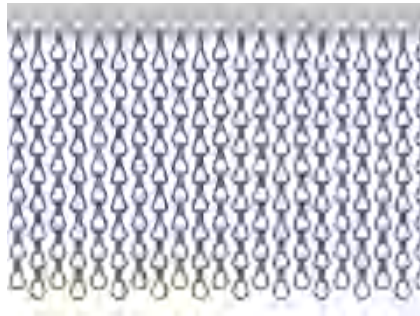

Half drop delicate

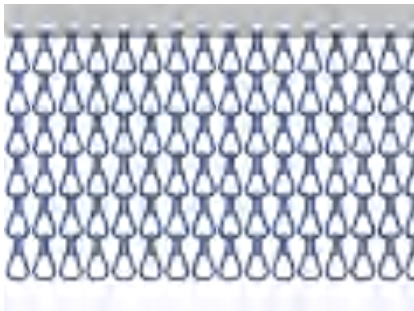

Classical standard

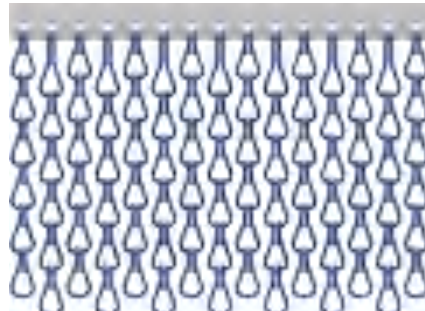

Half drop standard

Colors

Welcome to explore the numerous color possibility and art potential of chain link curtain.

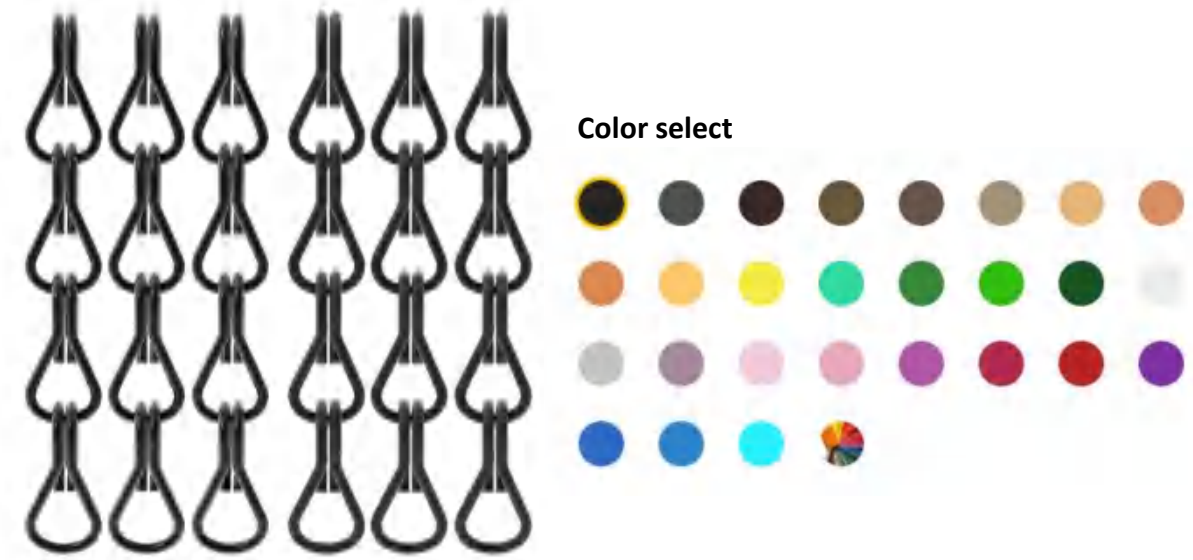

Applications

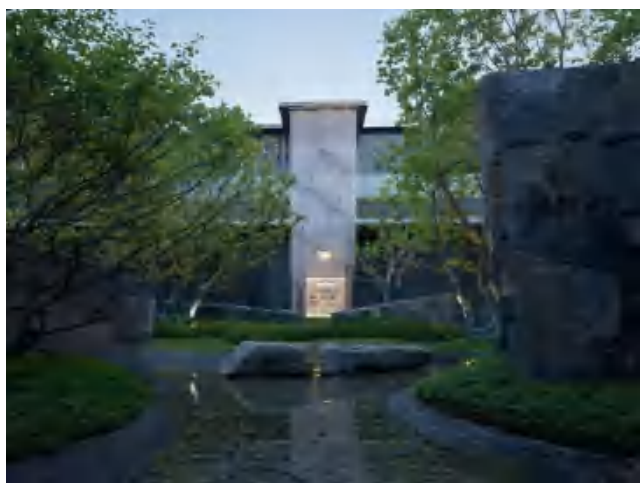

Stainless Steel Wire Rope Mesh

Stainless steel wire rope mesh is a highly durable and versatile material used in architectural, industrial, and safety applications. Composed of woven or ferrule-connected stainless steel cables, this mesh offers exceptional strength, flexibility, and corrosion resistance. Its unique properties make it an ideal choice for modern architectural facades, safety barriers, and animal enclosures.



Material: SS304, 316, 316L, etc.

Cable diameter: 1 ~ 4 mm

Cable structure: 7 × 7 (1.5 mm, 2 mm or 2.5 mm), 7 × 19 (3 mm, 4 mm)

Diamond size: 20 ~ 200 mm

Mesh Orientation: Horizontal, Vertical

Specification

Stainless Steel Rope Mesh (Ferrule Type), 7 × 7 Construction Wire Rope		
Mesh Aperture Width × Height (mm)	Wire Rope Diameter (mm)	Minimum Breaking Load (kN)
25x40	1.0	0.6
	1.6	1.5
30x50	1.0	0.6
	1.6	1.5
35x60	1.0	0.6
	1.6	1.5
	2.0	2.5
40x70	1.0	0.6
	1.6	1.5
	2.0	2.5
50x88	1.0	0.6
	1.6	1.5
	2.0	2.5
	3.0	5.7
	4.0	10.1
60x105; 70x120 80x140; 100x175 120x210; 160x275 180x310; 200x345	1.0	0.6
	1.6	1.5
	2.0	2.5
	3.0	5.7
	4.0	10.1
	5.0	15.9

Stainless Steel Rope Mesh (Knotted), 7 × 7 Construction Wire Rope		
Mesh Aperture Width × Height (mm)	Wire Rope Diameter (mm)	Minimum Breaking Load (kN)
25x25	1.2	0.8
	1.6	1.5
30x30	1.2	0.8
	1.6	1.5
40x40	1.2	0.8
	1.6	1.5
	2.0	2.5
50x50	1.2	0.8
	1.6	1.5
	2.0	2.5
60x60	1.2	0.8
	1.6	1.5
	2.0	2.5
	2.4	3.4
	3.0	5.7
75x75; 90x90 100x100;120x120	1.2	0.8
	1.6	1.5
	2.0	2.5
	2.4	3.4
	3.0	5.7
	4.0	10.1

Stainless Steel Rope Mesh, 7 × 19 Construction Wire Rope		
Mesh Aperture Width × Height (mm)	Wire Rope Diameter (mm)	Minimum Breaking Load (kN)
150x260	3.2	7.38
120x208	3.2	7.38
100x173	3.2	7.38
90x156	3.2	7.38

The type of Stainless Steel wire rope mesh

1. Knotted mesh is a kind of plain weave, each warp wire rope crosses alternately above and below each weft wire rope. Warp and weft wire ropes generally have the same diameter.
2. Ferruled mesh has the same physical properties as the knotted mesh, the only difference is in the combination style, the stainless wire rope are combined by the ferrules which are made of the same



Knotted mesh



Ferruled mesh

grade stainless steel.

Structure

Wire rope structure:

7 × 7, 7 × 19

Opening angle:

20°, 30°, 60°, 70° and 75° are set as standard opening, and optimal stretched at 60°.

Ferrule type:

both ferrule and opened ferrule available

M: mesh aperture

D: diameter

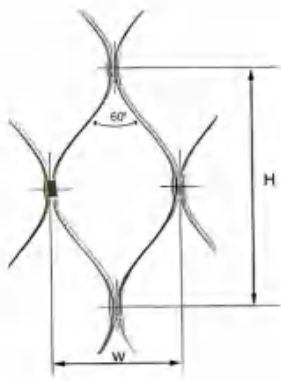
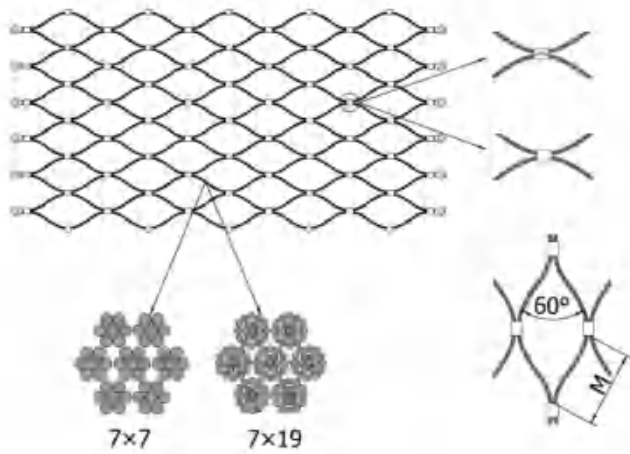

60°=standard angle
W=Mesh (short diagonal)
H=Mesh (long diagonal)

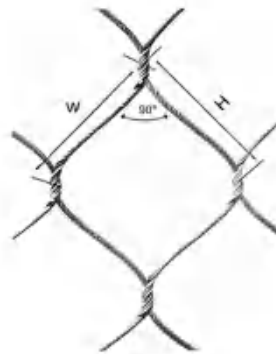

90°=standard angle
W=Mesh (short diagonal)
H=Mesh (long diagonal)

Features

Quality material, High flexibility, Anti-corrosion, Longevity, Cost effectiveness, Easy assembly and durability.

Flexible structure and easy packaging & transportation.

Excellent corrosion resistance & weather resistance.

Unique design.

Applications





Laminated Glass Metal Mesh

Metal Mesh Laminated Glass is a special kind of laminated glass. Compared with common laminated glass, wire laminated glass has copper wire, steel wire in the EVA inter layer. So wire laminated glass has all the features of laminated glass, such as safety, pressure and sound insulation, energy-saving. Besides, wire laminated glass has various visual effects and senses.



Inter-layer wire mesh material: stainless steel, copper, brass, aluminum alloy, etc. It can offer by client or we offer to fitting the request.

Glass type: common laminated glass,tempered laminated glass,coated laminated glass,low-e laminated glass,silkscreen laminated glass,bulletproof laminated glass,fireproof laminated glass, etc.

Type

Varieties: Embossed wired patterned glass, polished wire glass, colored wired glass, etc.

Shapes: Flat laminated glass, waveform laminated glass, grooved laminated glass, etc.

Specification

Whole thickness: 3 + 0.38 + 3 mm, 3 + 0.76 + 3 mm,4 + 0.38 + 4 mm,4 + 0.76 + 4 mm,5 + 0.38 + 5 mm,5 + 0.76 + 5 mm,6 + 0.38 + 6 mm,6 + 0.76 + 6 mm, 8 + 0.76 + 8 mm, 10 + 0.76 + 10 mm, etc.

Popular sizes: (other can be customized)300 × 300 mm, 1220 × 1830 mm, 1500 × 2000 mm,1530 × 2520 mm,1830 × 2440 mm,2000 × 2500 mm,2140 × 3300 mm,2250 × 3600 mm,2800 × 7000 mm,3000 × 8000 mm.

Laminated Glass Performance Levels according to Thickness			
Glass Characteristic	Thickness (mm)	UV transmittance (%)	LT (%)
3+0.38+3mm Clear	6.38mm	5	89
6+0.38+6mm Clear	12.38mm	3	86
6+0.38+6mm Reflective	12.38mm	0.5	22
More product requests please contact us for customization			

REQUIREMENT	BENEFIT	GLASS ASSEMBLY
Solar control	Energy saving	2ply+1PVB interlayer
	UV elimination	
Sound control	Noise reduction	2ply+1PVB interlayer
Safety	Lowest injury risk	2ply+2PVB interlayers
	Anti-bandit protection	2ply+4-6PVB interlayers
Security	Forced entry protection	3ply+4PVB interlayers
	Bullet proof	Decide case by case,at least
	Blast resistant	4ply+multi PVB interlayers

Technology

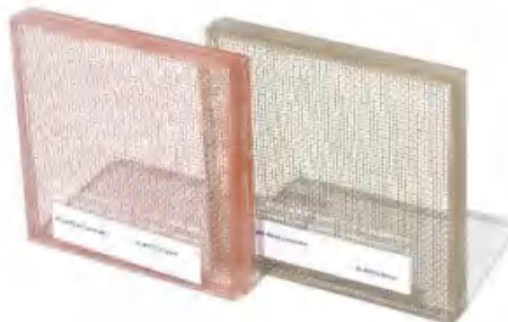

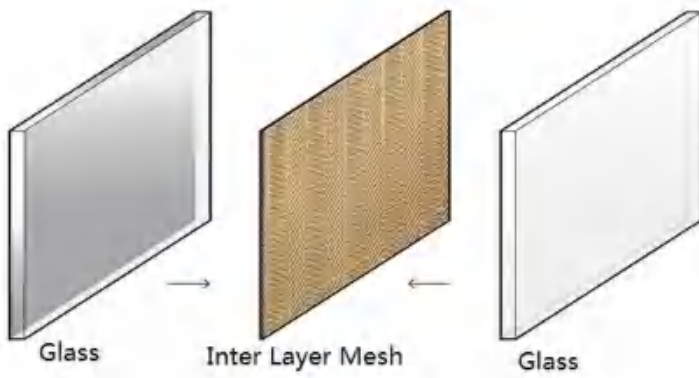

Mesh laminating gives the opportunity to encapsulate a wide variety of woven metal meshes within protective glass layers. Combining the decorative and aesthetic qualities of our range of finely woven gauzes and braided weaves with structural strength and practicality of glass.

Features

Decorativeness: Laminated glass metal mesh can do a lot of patterns and also support pattern customization

Safety: Its impact strength is 5–10 times that of ordinary glass.

Fire Retardancy:

It can withstand the temperature difference of 300 °C, and can withstand the temperature difference is 3 times that of ordinary glass. Wire or net can also support debris, which can maintain integrity to a considerable extent and prevent the flow of air and the diffusion of smoke, which has a good effect on the spread of fire.

Applications



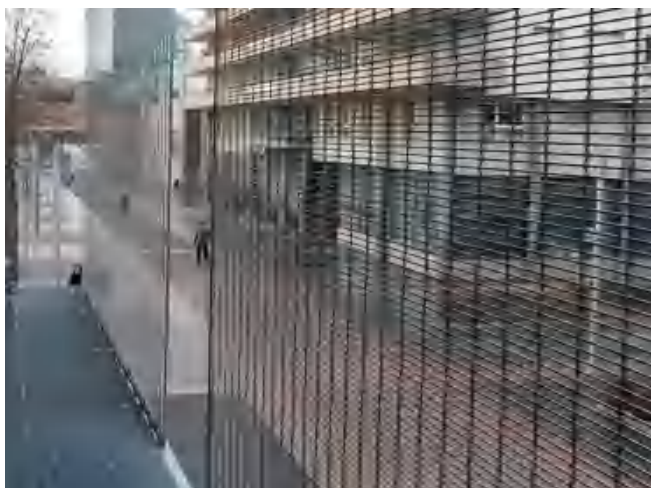

S Hook Ring Mesh Curtain

S hook ring mesh curtain consists of many metal circle rings and S hook fittings and is a new type metal decorative wire mesh. S hook ring mesh curtain is similar to chainmail curtain, but metal rings are connected in different ways, thus presenting different visual effect. S hook ring mesh curtain has a larger mesh spacing than that of chainmail curtain, therefore, it has higher transparency and better visibility. S hook ring mesh curtain is light and flexible. It is widely used in various building spaces and serves as space divider, curtain, wall and ceiling decorative material.

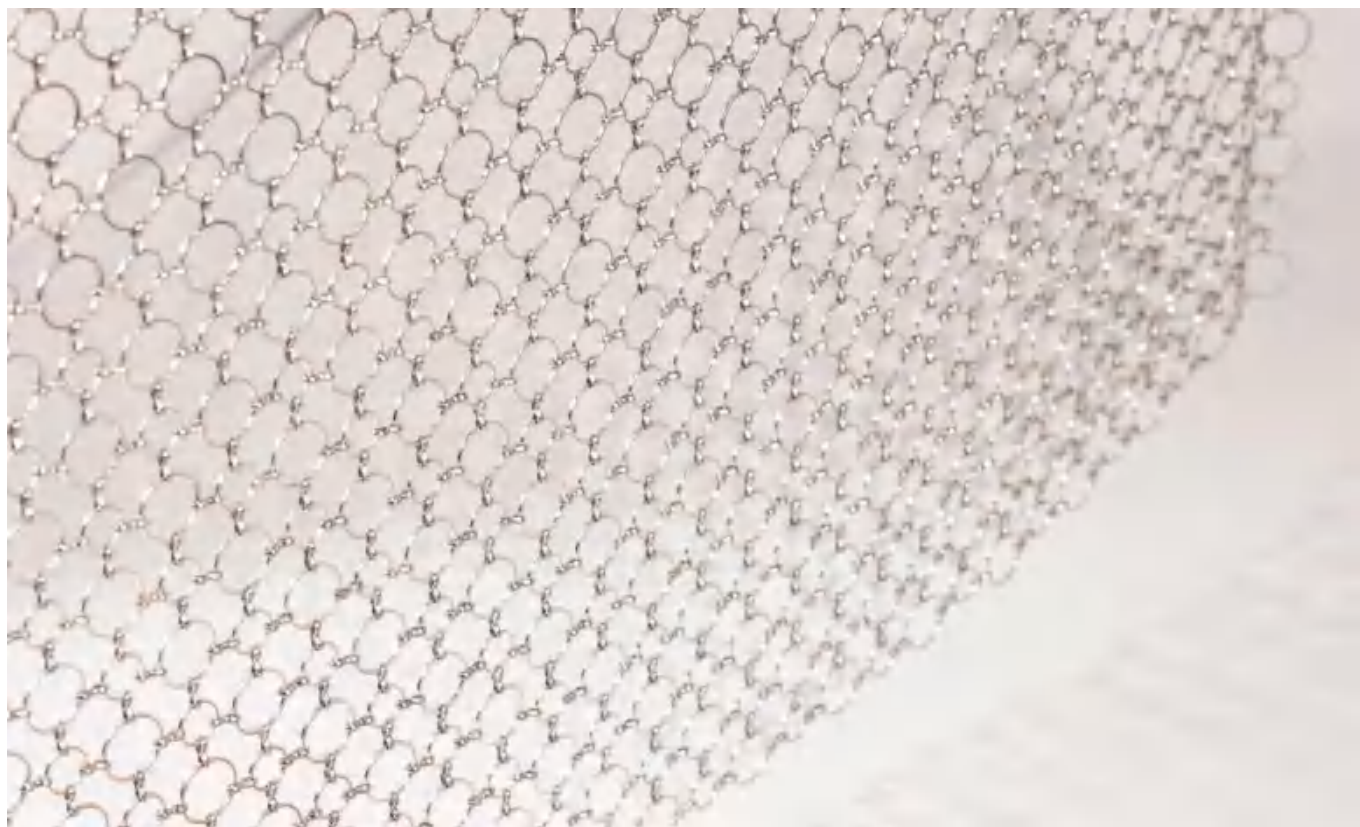

Specification

Material: carbon steel, stainless steel, aluminum, copper

Color: gold, silver, copper, black; color can be customized.

Curtain width: max. 9.6 m
Curtain length: max. 15 m
Surface treatment: painted and polished
Wire diameter (a): 0.5–2.0 mm
Ring diameter (b): 3.8–24 mm
S hook length (c): 13 mm

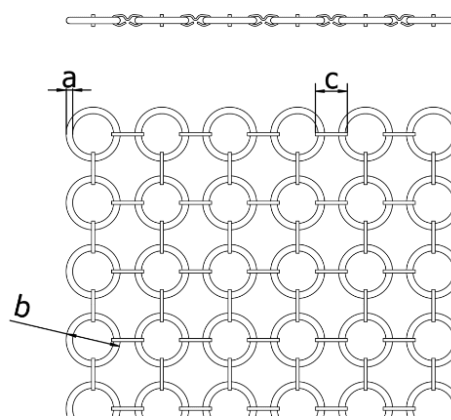

Category

We provide product types that perfectly meet your personalized needs based on the architectural styles.

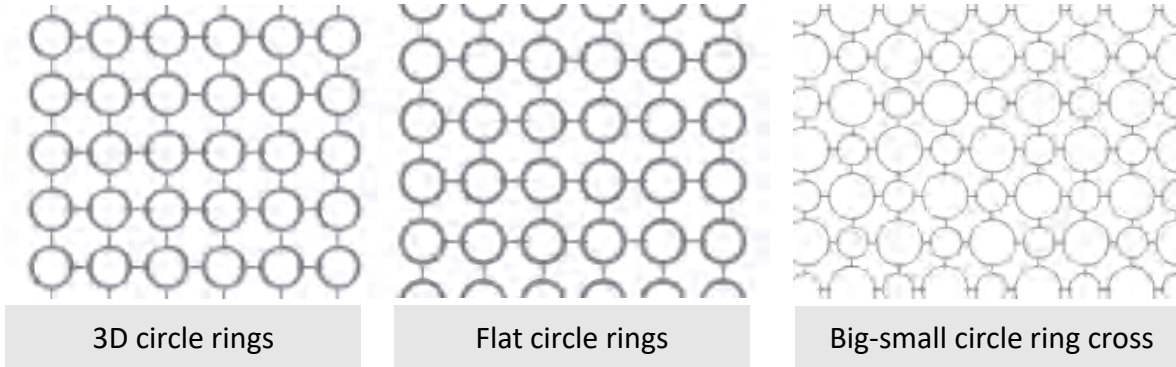

The Common Specifications for Metal Ring Mesh:

Item	Wire Diameter	Ring Diameter	Ring Count(pcs/m ²)
WR-1820	1.8mm	20mm	4600
WR-1312	1.3mm	12mm	12000
WR-1212	1.2mm	12mm	12000
WR-1210	1.2mm	10mm	21000
WR-1110	1.1mm	10mm	21000
WR-0807	0.8mm	7mm	37000

Material: Mild Steel, Aluminum, Stainless Steel, Brass, Bronze, etc.

Dimensions: According to client's requirements. The width and length should generally be controlled below 3m and 10m.

Finishes

From original color to bright gold, we provide S hook ring mesh curtain color customization services to added both the practicability and aesthetic of our products.

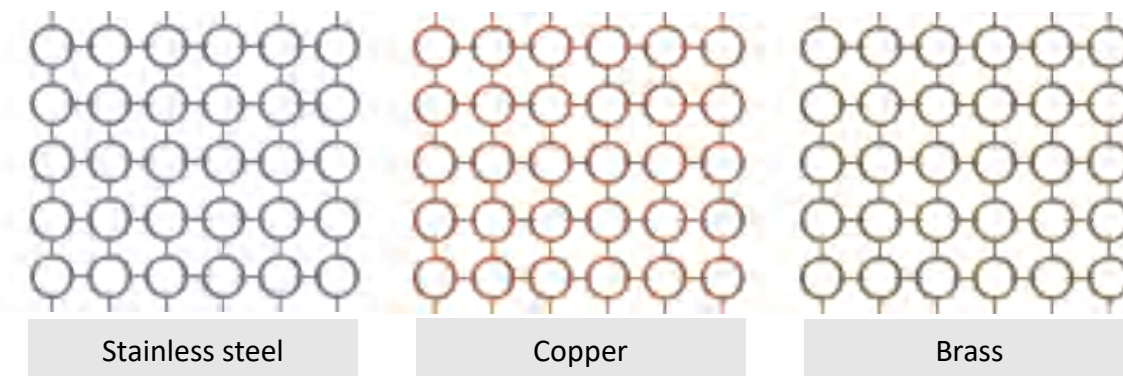

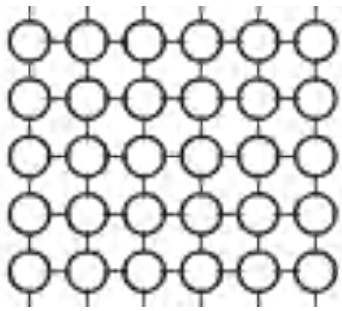

Black

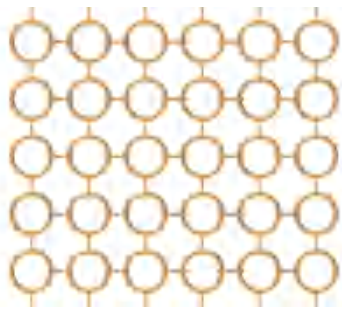

Gold

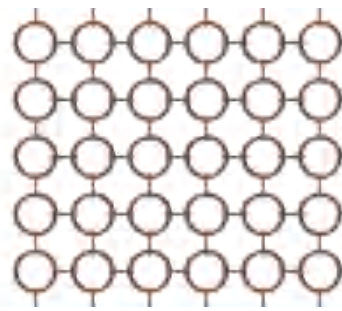

Bronze

Installation

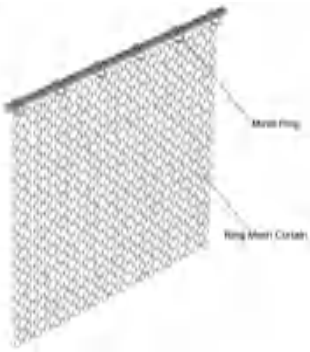

Curtain Rod & Loop

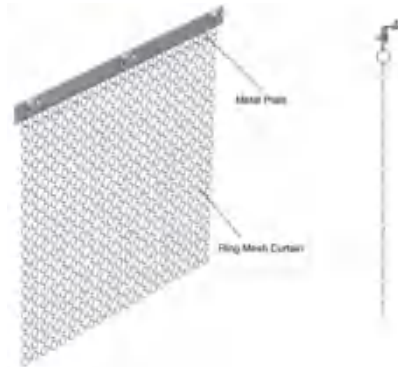

Metal Plate - Ceiling

Applications

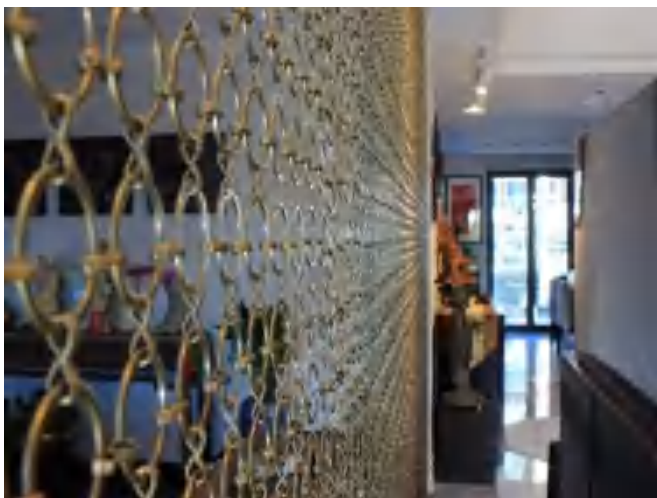

Metallic Fabric Cloth

Metallic fabric cloth has a network structure consisting of 4-leg metal sequins and metal rings. It feels like cloth and has good roughness and is light and flexible. Countless sequins make the curtain reflect scale-like light-shadow effect. It is commonly used in both interior and exterior building decorations, art designs, stage backgrounds, exhibition hall designs, etc. Compared with metal coil drapery and chain link curtain, metallic fabric cloth has little gap and can play the role of blocking or decorating walls.



Specification

Material: aluminum

Size (a): 4 mm, 6 mm, 8 mm, 10 mm

Shape: octagonal, round, quincuncial, spherical

Color: gold, purple, red, blue, green, silver, brown, black, original color; color can be customized.

Surface treatment: anodized and painted

Finish: gloss, colorful, dull polished, painted

Curtain length & width: customized upon request.

Category

Flexible, changeable metal sequin shapes bring you magic decorative effects.

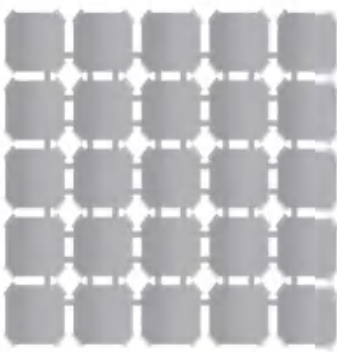

Octagonal

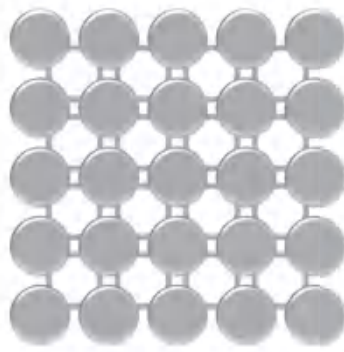

Round



Quincuncial



Spherical

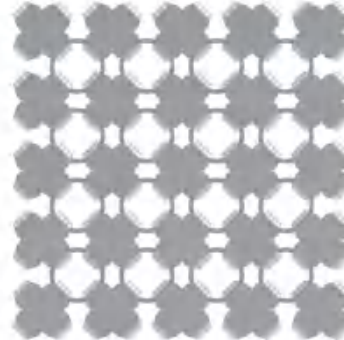

Four-leaf clover

Finishes

Multilayer colors and shining finish effects can inspire your design inspiration.



Gloss



Dull Polished



Colorful



Painted

Installation

Flexible installation methods guarantee your project can present the best effect.

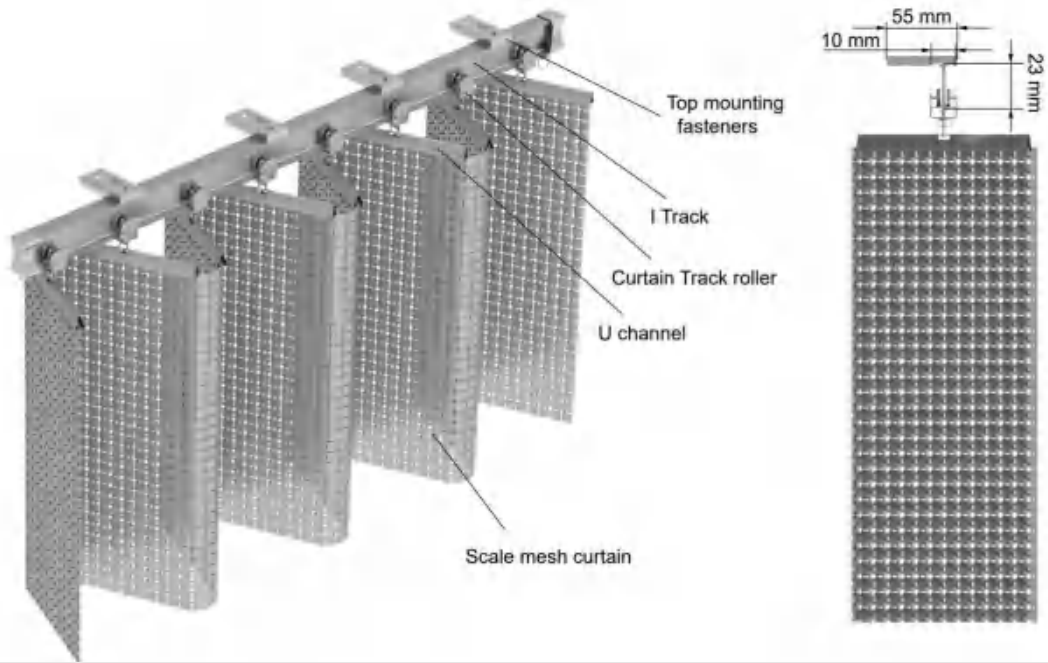

I Track

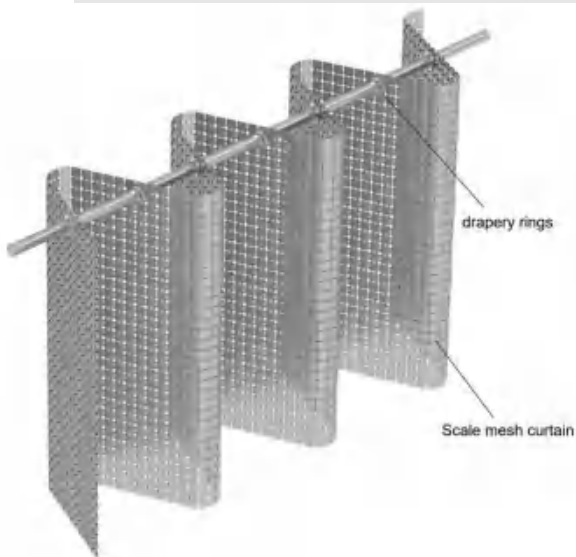

Curtain Rod

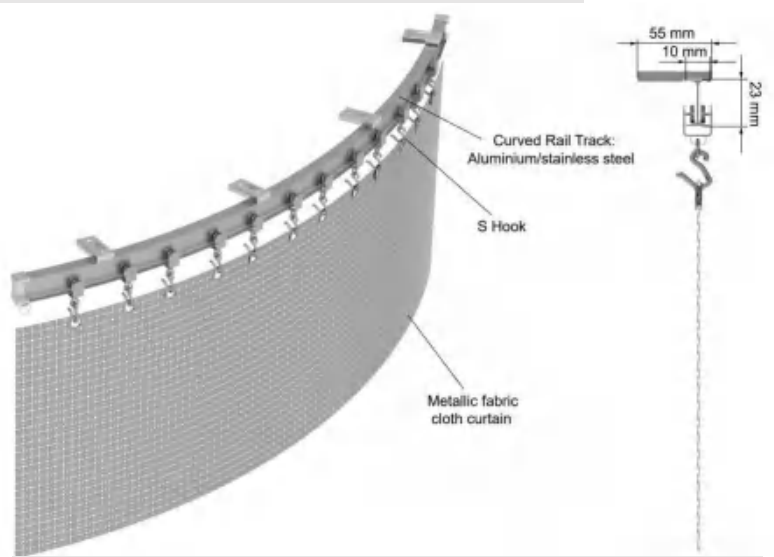

Grommet & I Curved Track

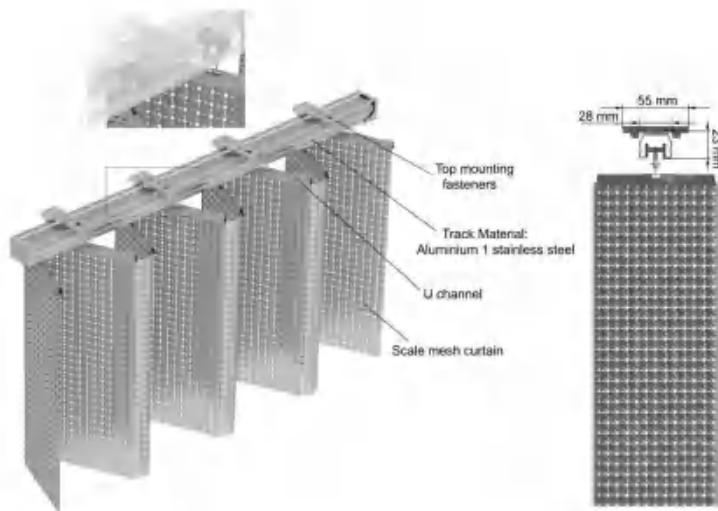

Sliding Orbit

Features

Unique Design. The aluminum material and ring connection structure ensure the durability and firm.

Various Colors. The metallic fabric cloth can be various colors, which can suit more applications and places.

Flexible. Installed on the track, the metallic fabric cloth is flexible to open or closed.

Lightweight and Easy to Install and Remove. The aluminum material is lightweight, it can be installed and removed without any efforts.

Easy to Clean. With the smooth surface, it doesn't require harsh cleaner or solvents, just wipe with a cloth.

Various Applications. The metallic fabric cloth can be used as ceiling decorations, wall decorations, window curtains and various other applications.

Applications

Space divider

Window curtain

Table runner

Wall decoration

Ceiling decoration

Handbags

Garments



Metal Bead Curtain

Metal bead curtain is made of high quality metal beads that can capture and reflect light to create an energetic, fantastic space atmosphere. No matter being used for art designs, building decoration, or acting as a simple, elegant curtain, metal bead curtain can easily blend into all kinds of environments. Meanwhile, metal bead curtain is a good solution that creates a perfect space divider without introducing a fixed partition. It not only adds the sense of beauty to the space, but also ensures people can pass through the curtain freely.



Specification

Material: low carbon steel and stainless steel

Bead shape: round, faceted

Diameter: 3 mm, 4 mm, 5 mm, 6 mm, 8 mm, 10 mm, 12 mm

Length: customized upon request

Finish: gloss or matte

Surface treatment: electroplated, anodized

Category

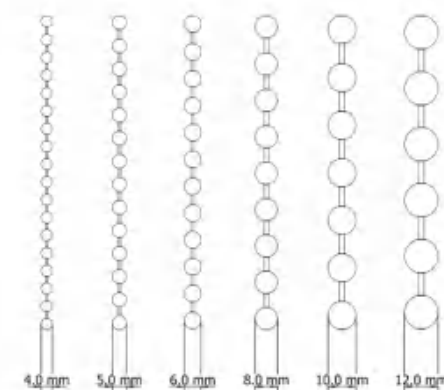

Browse metal bead curtain and obtain unique, modern metal bead curtain category guidance.

Round & Faceted

Round and faceted beads have their own features. Round metal bead has a smooth surface and looks more gentle and is suitable for any building environments. Faceted metal bead has better refraction and scattering effects and is more suitable for stages and spaces with higher light effect requirements.

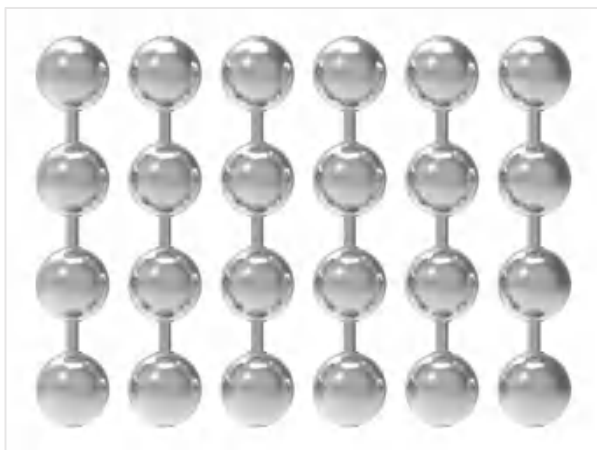

Round

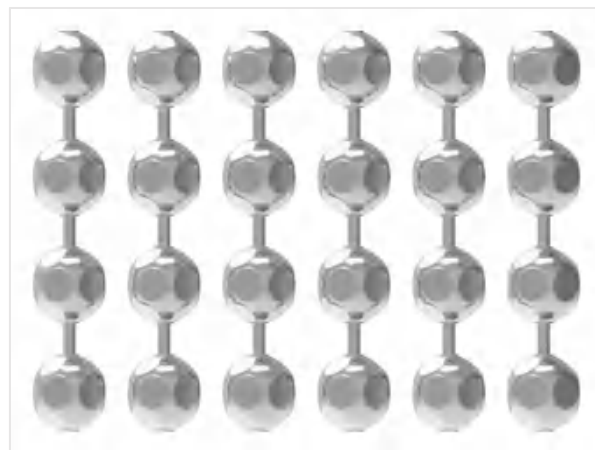

Faceted

No Spacing & Spacing

Our metal bead curtain can be divided into no spacing and spacing types. We will adjust the space between metal metals based on the overall visual effect.

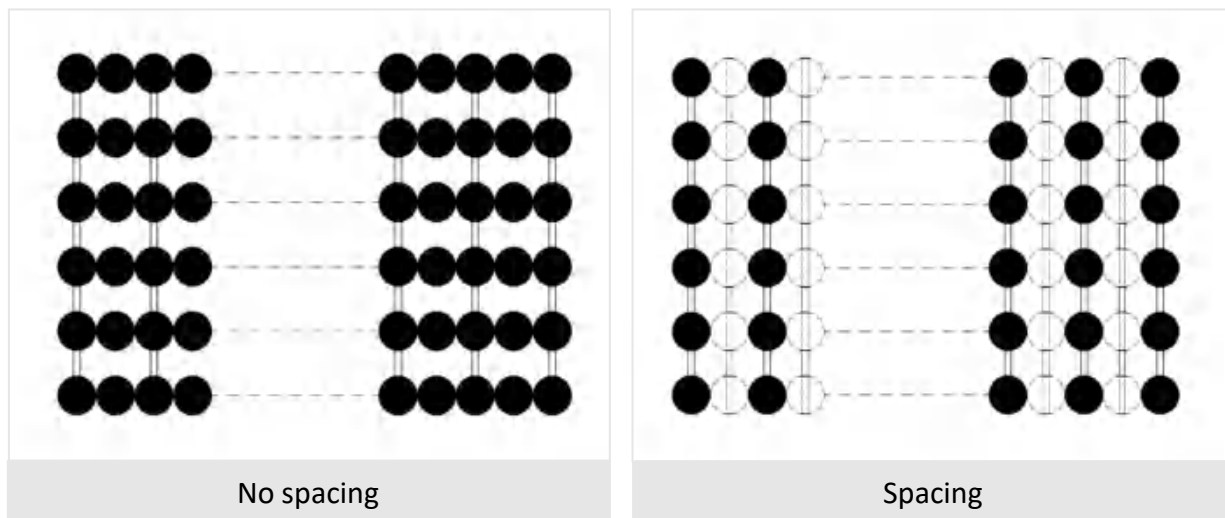

Finishes

Regardless of classical color or popular color, our metal bead curtain can be customized according to your unique style.

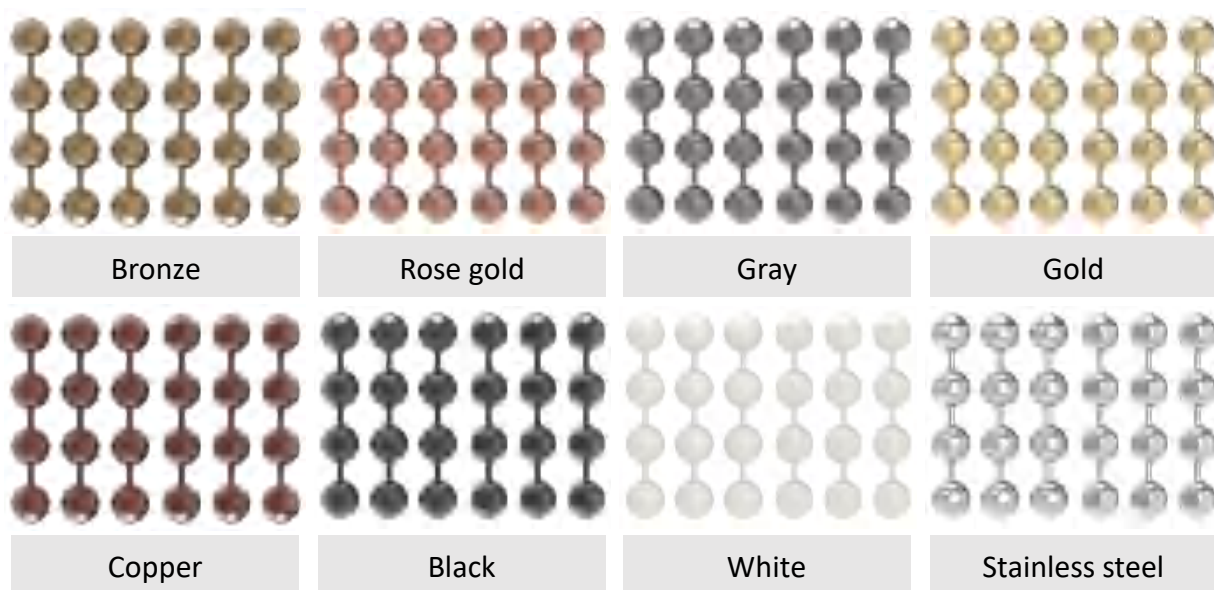

Installation

Metal bead curtain is provided with durable installation tracks and necessary accessories to achieve worry-free installation.

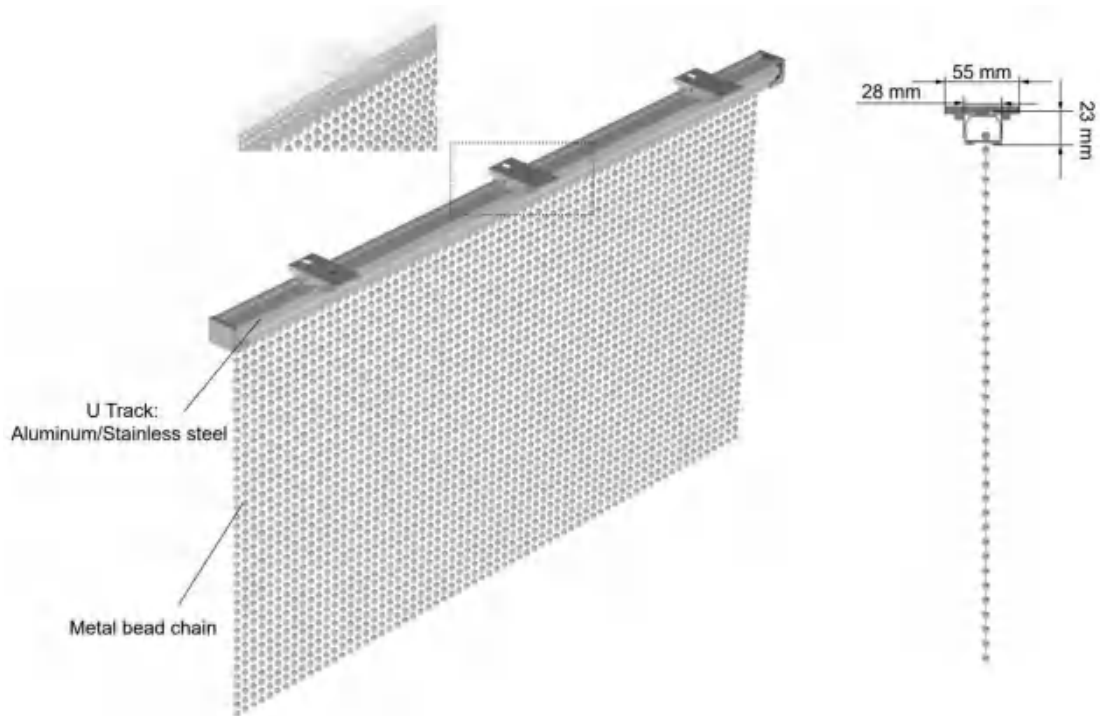

U Track

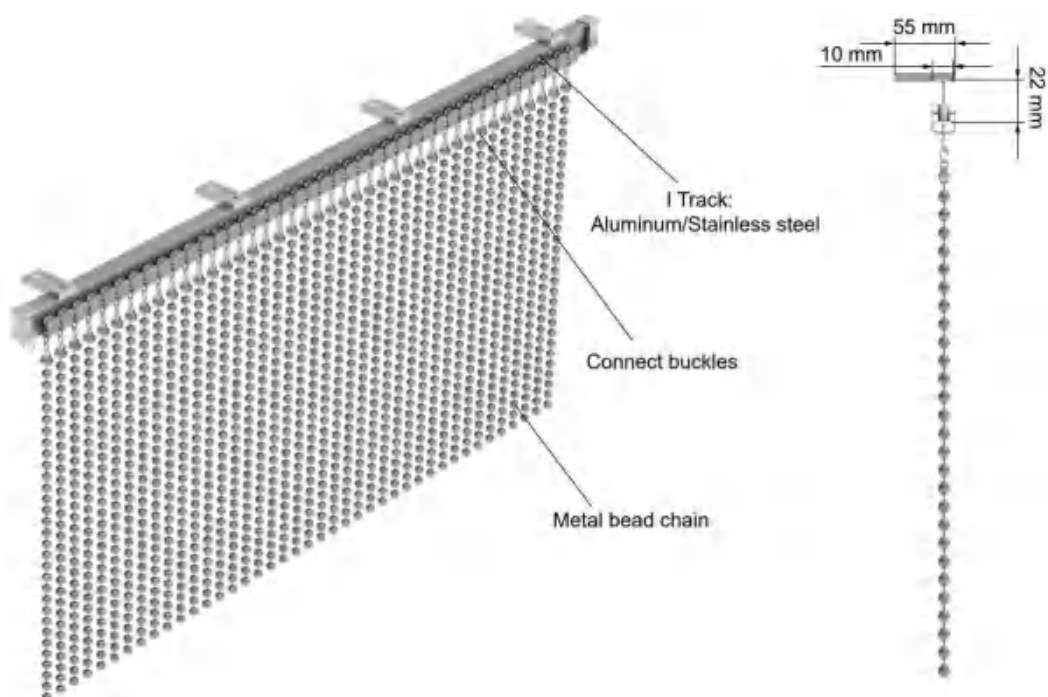

I Track

Features

- Flame retardant.
- Lightweight and flexible.
- Never rust.
- Anti-corrosion.
- Easy to install.
- Natural drooping.

No maintenance.

Applications

Metal bead curtain is a fashion and modern design element that applicable for space divider, wall coverings, window treatments, shading protection and so many functions.

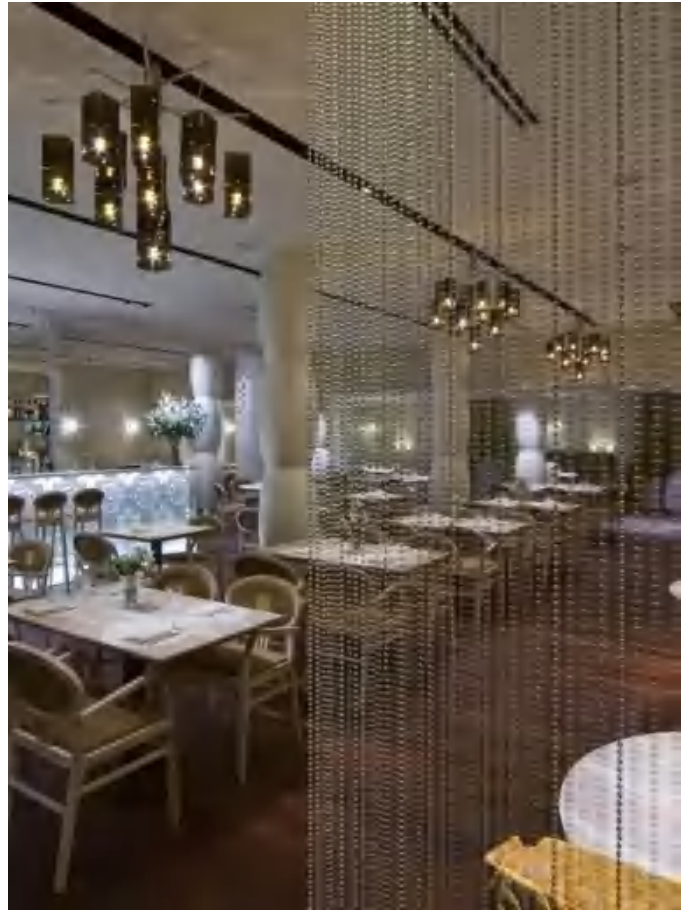



Decorative Wire Mesh

